

# SYNEGO<sup>®</sup>

TECHNISCHE INFORMATION  
PROFILDRUCK

**MASTERVORLAGE**

ist den landesspezifischen Vorgaben  
anzupassen. Stand 10.2014



**Inhaltsverzeichnis**

Blendrahmen AD . . . . .	2
Pfosten-Kämpfer AD . . . . .	4
Blendrahmen MD . . . . .	6
Pfosten-Kämpfer MD . . . . .	9
Flügel . . . . .	11
Flügelsprossen . . . . .	17
Profile für mehrflügelige Fenster ohne festen Pfosten . . . . .	18
Zubehör für mechanische Verbindungen . . . . .	22
Zubehör für mechanische Verbindungen . . . . .	23
Bodenschwelle und Zubehör . . . . .	25
Zubehör auswärts öffnende Elemente . . . . .	29
Zubehör für Haus- und Nebeineingangstüren . . . . .	30
Bohrlehren . . . . .	31
Armierungen . . . . .	32
Artikelverzeichnis . . . . .	40
Zeichenerklärung . . . . .	44
Variantensystematik . . . . .	44
Artikelsystematik in SAP . . . . .	44
Variantensystematik in SAP . . . . .	44
Materialnummer . . . . .	44
Tableau Standardfarben . . . . .	a
Kaschierung innen . . . . .	d

**Blendrahmen AD**

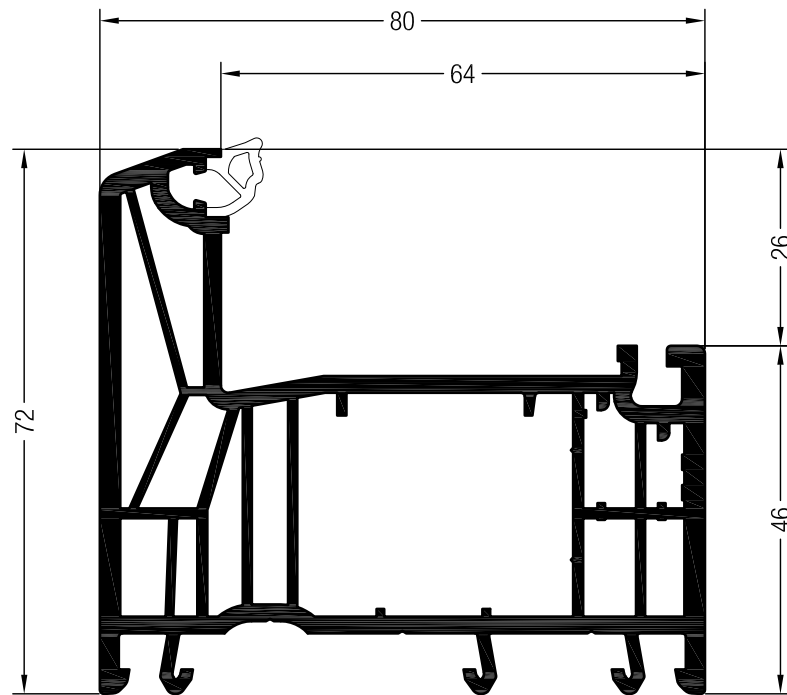

Blendrahmen 72 AD SYNEGO®

- 1537005
- 1567005
- 24

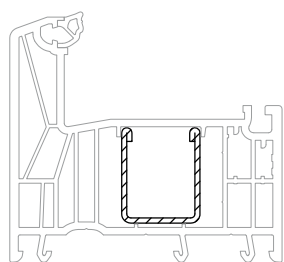

23 x 28

	<b>1306619</b>
	1,5
lx	1,1
ly	1,1
	6

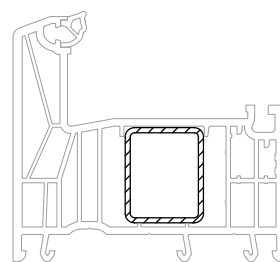

23 x 28

	<b>1357540</b>
	1,5
lx	1,1
ly	1,5
	6

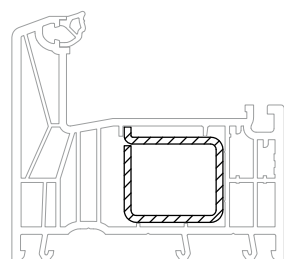

29 x 28

	<b>1357550</b>
	2
lx	2,3
ly	1,8
	6

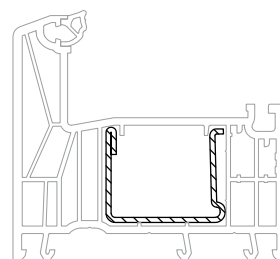

35 x 28

	<b>1244516</b>	<b>1244526</b>
	1,5	2
lx	2,7	3,5
ly	1,3	1,7
	6	6

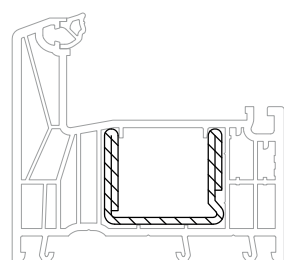

23 x 28

	<b>1244536</b>
	2
lx	5
ly	2
	6

**Blendrahmen AD**

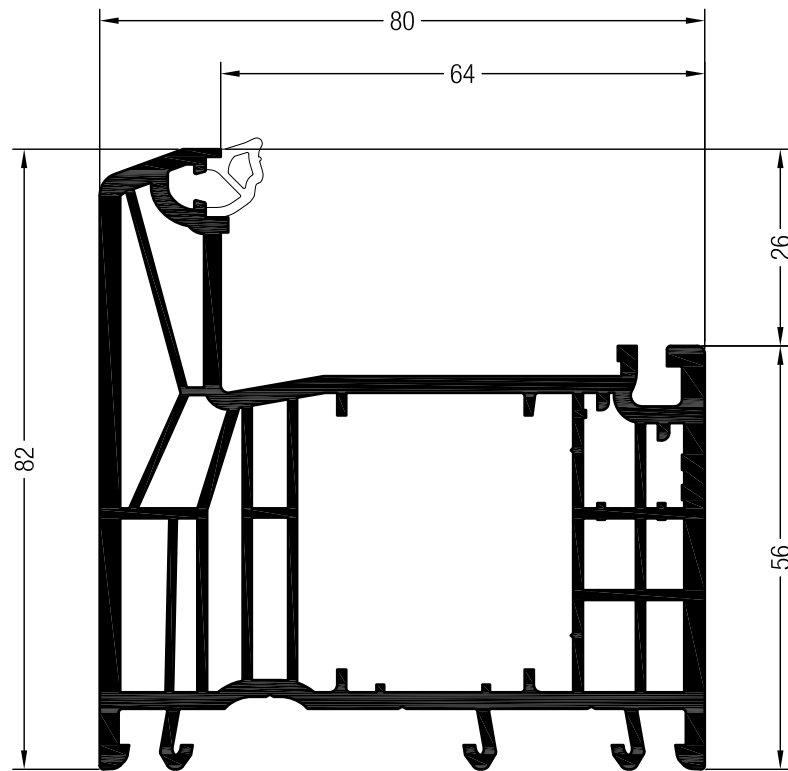

Blendrahmen 82 AD SYNEGO®

- 1537015
- 1567015
- 24

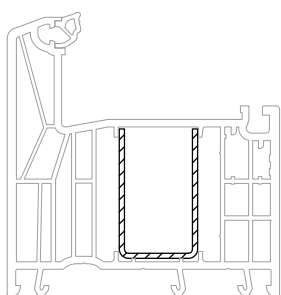

23 x 38

	<b>1357541</b>
	1,5
lx	1,4
ly	2,1
	6

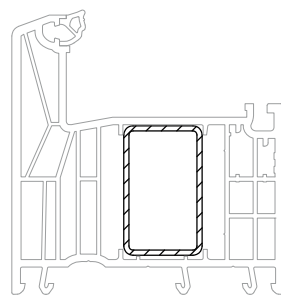

23 x 38

	<b>1357542</b>
	1,5
lx	1,5
ly	3,2
	6

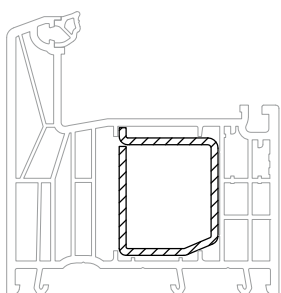

29 x 37,5

	<b>1357559</b>
	2
lx	2,9
ly	3,9
	6

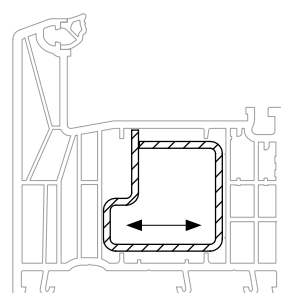

35 x 36

	<b>1357543</b>
	2
lx	3,6
ly	3,7
	6

**Pfosten-Kämpfer AD**

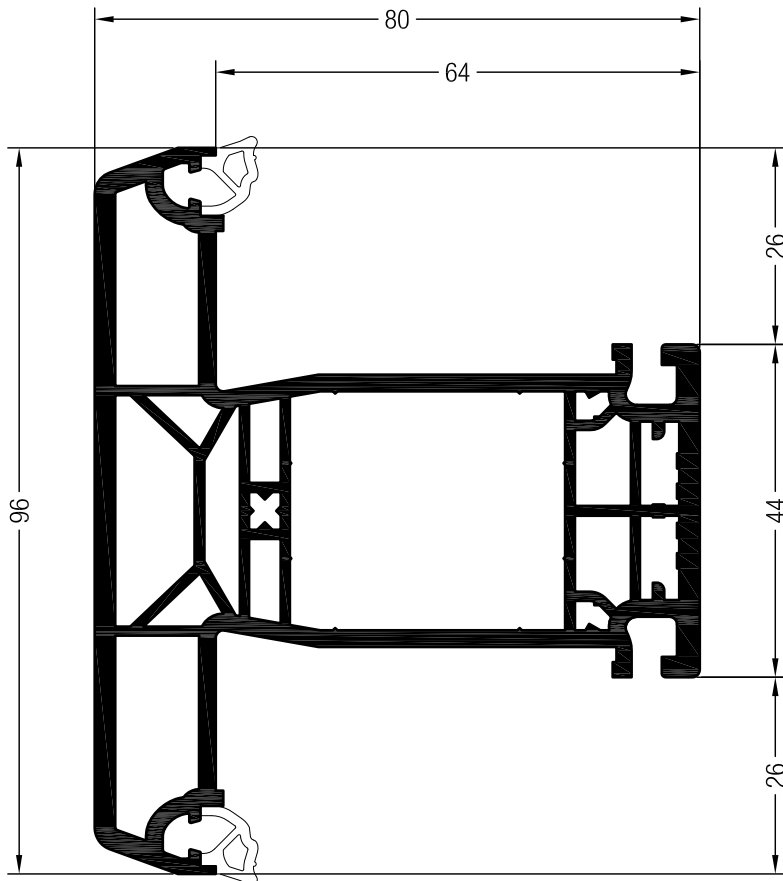

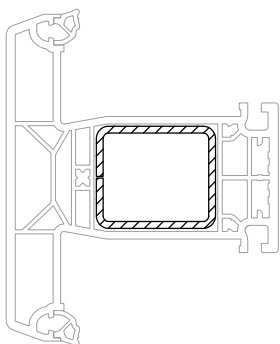

Pfosten 96 AD SYNEGO®

- 1537405   
- 1567405   
-  24



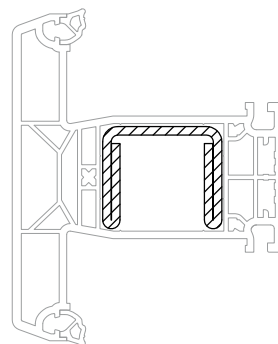

35 x 30

	<b>1357544</b>
	2
lx	4
ly	3,1
	6



35 x 30

	<b>1357551</b>
	2,5
lx	6,6
ly	2,9
	6

**Pfosten-Kämpfer AD**

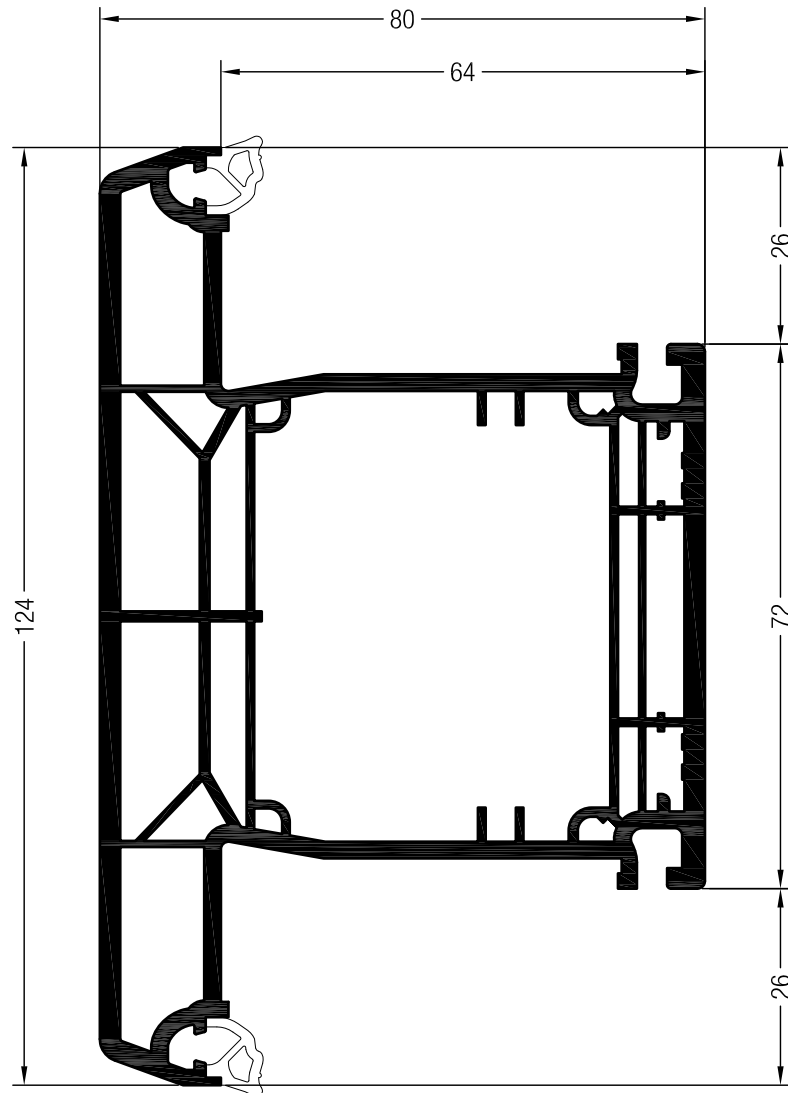

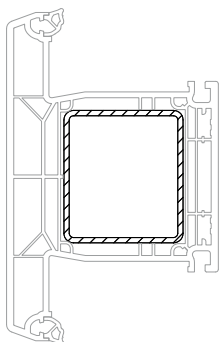

Pfosten 124 AD SYNEGO®

- 1537415  
- 1567415  
-  12



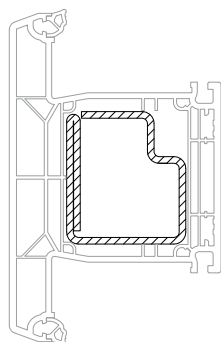

45 x 50

	<b>1357545</b>
	2
lx	11,1
ly	13,1
	6



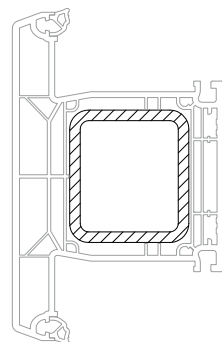

45 x 50

	<b>1357546</b>
	2,5
lx	14,1
ly	15,4
	6



45 x 50

	<b>1357553@</b>
	4
lx	18,6
ly	22
	6

**Blendrahmen MD**

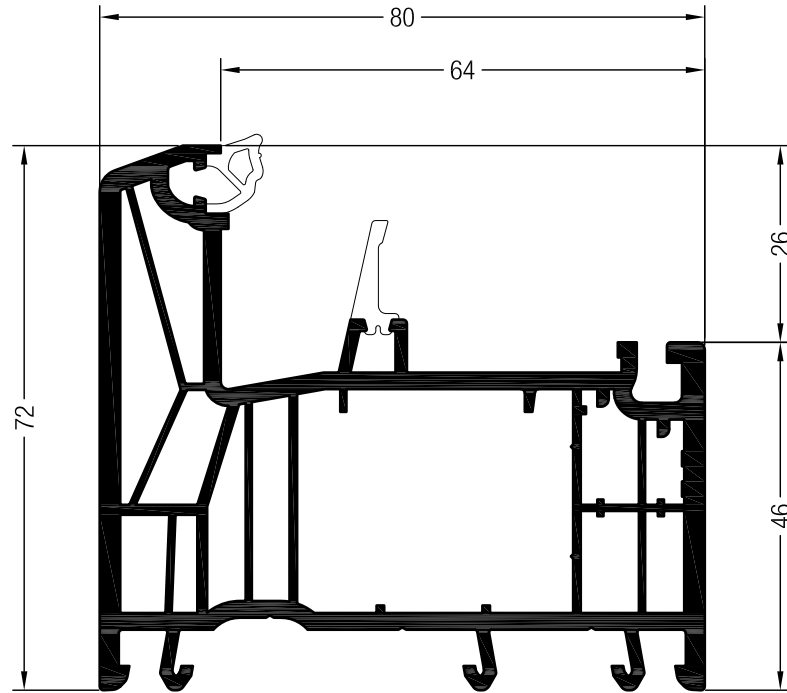

Blendrahmen 72 MD SYNEGO®

- 1537105
- 1567105
- 24

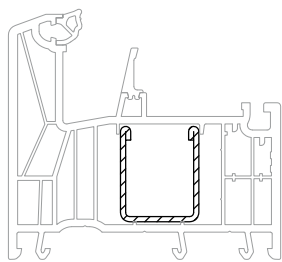

23 x 28

	<b>1306619</b>
	1,5
lx	1,1
ly	1,1
	6

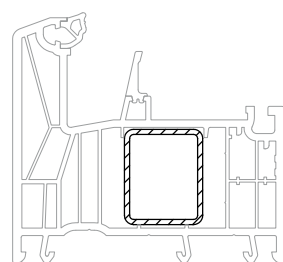

23 x 28

	<b>1357540</b>
	1,5
lx	1,1
ly	1,5
	6

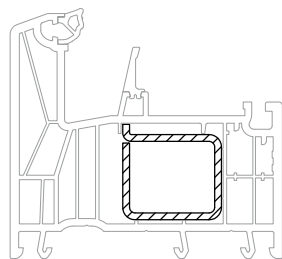

29 x 28

	<b>1357550</b>
	2
lx	2,3
ly	1,8
	6

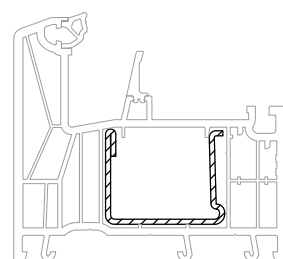

35 x 28

	<b>1244516</b>	<b>1244526</b>
	1,5	2
lx	2,7	3,5
ly	1,3	1,7
	6	6

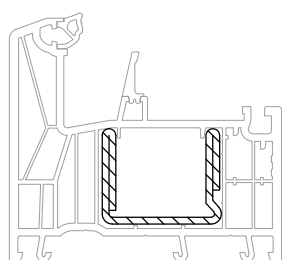

23 x 28

	<b>1244536</b>
	2
lx	5
ly	2
	6



**Blendrahmen MD**

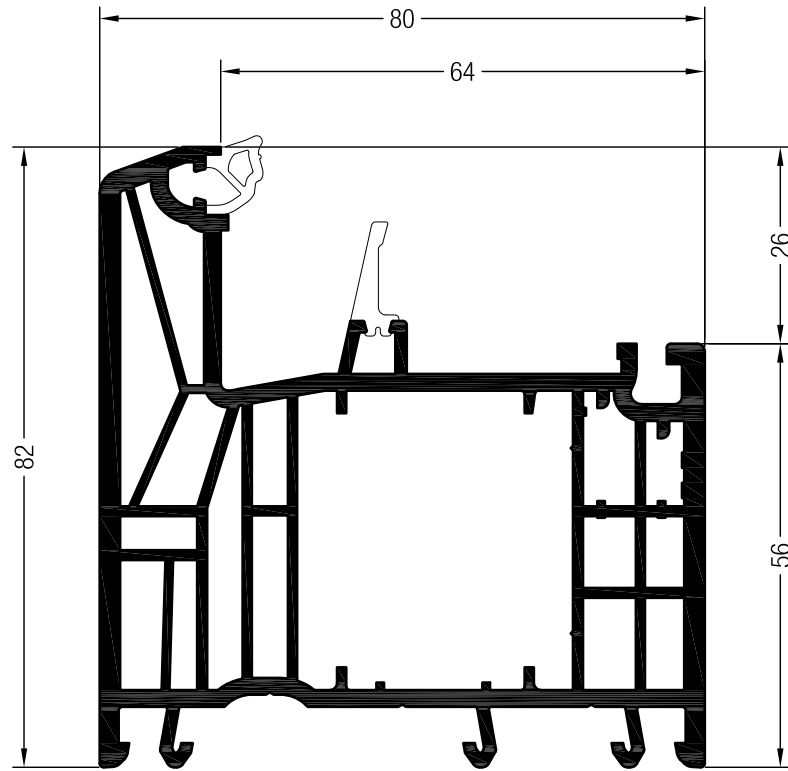

Blendrahmen 82 MD SYNEGO®

- 1537115
- 1567115
- 24

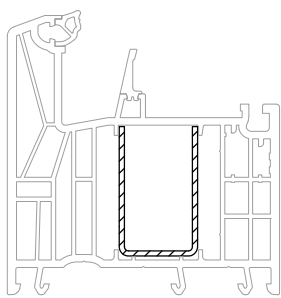

23 x 38

	<b>1357541</b>
	1,5
lx	1,4
ly	2,1
	6

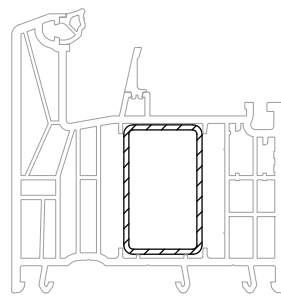

23 x 38

	<b>1357542</b>
	1,5
lx	1,5
ly	3,2
	6

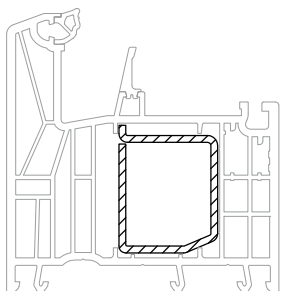

29 x 37,5

	<b>1357559</b>
	2
lx	2,9
ly	3,9
	6

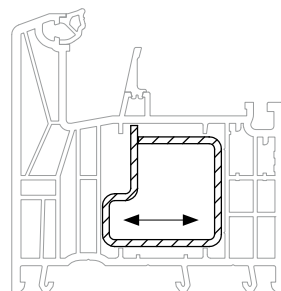

35 x 36

	<b>1357543</b>
	2
lx	3,6
ly	3,7
	6

**Blendrahmen MD**

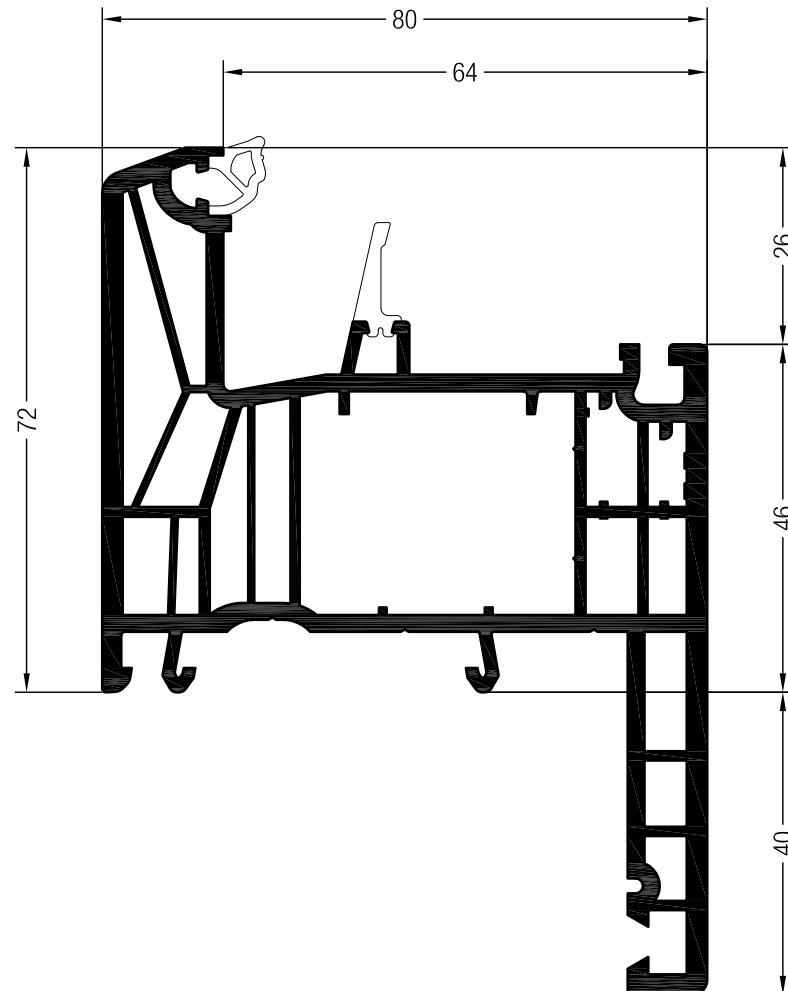

Blendrahmen 72/40 MD SYNEGO®

- 1537165
- 1567165
- 24

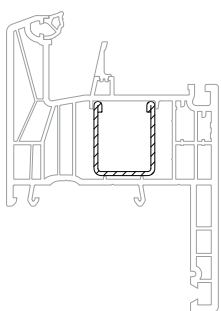

23 x 28

	<b>1306619</b>
	1,5
lx	1,1
ly	1,1
	6

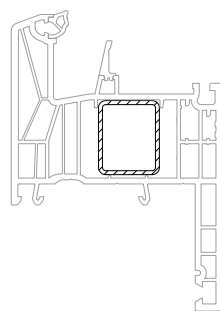

23 x 28

	<b>1357540</b>
	1,5
lx	1,1
ly	1,5
	6

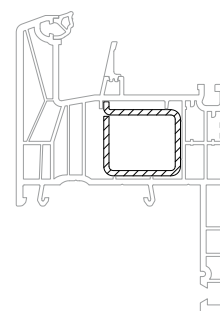

35 x 25

	<b>1357550</b>
	2
lx	2,3
ly	1,8
	6

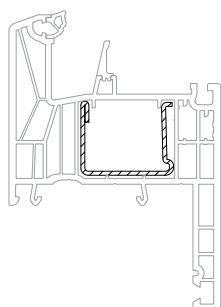

35 x 28

	<b>1244516</b>	<b>1244526</b>
	1,5	2
lx	2,7	3,5
ly	1,3	1,7
	6	6

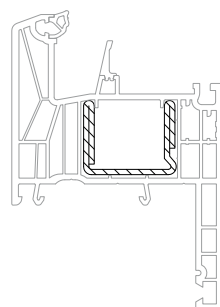



35 x 28

	<b>1244536</b>
	2
lx	5
ly	2
	6

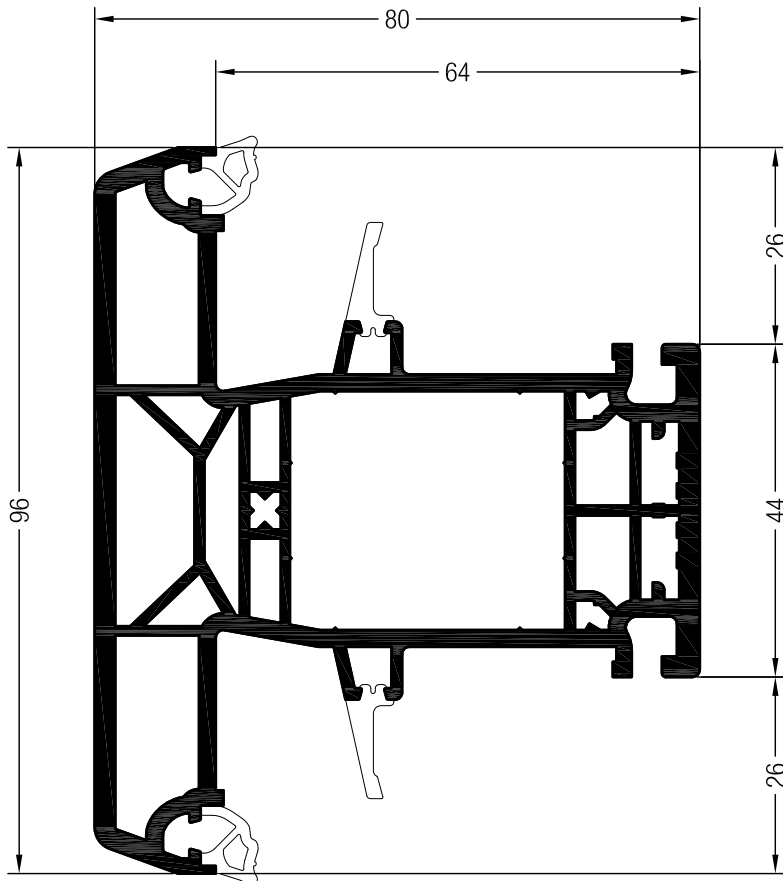
**Pfosten-Kämpfer MD**



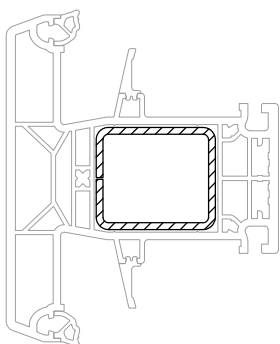

Pfosten 96 MD SYNEGO®

- 1537505  
- 1567505  
-  24



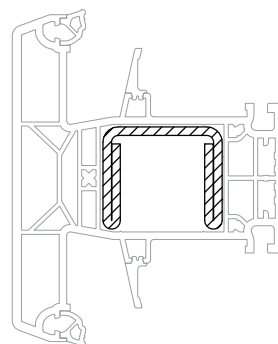

35 x 30

	<b>1357544</b>
	2
lx	4
ly	3,1
	6



35 x 30

	<b>1357551</b>
	2,5
lx	6,6
ly	2,9
	6

**Pfosten-Kämpfer MD**

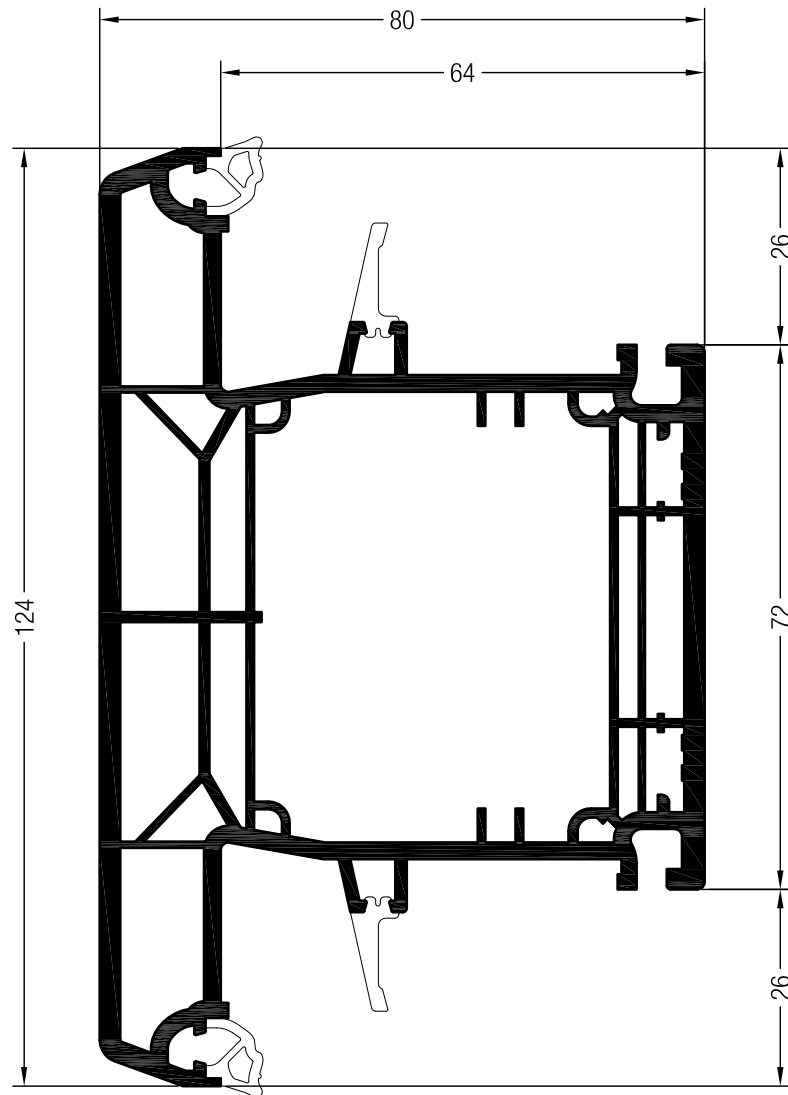

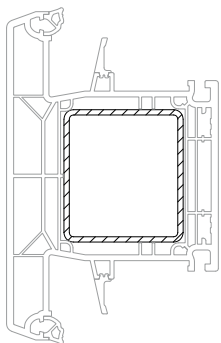

Pfosten 124 MD SYNEGO®

- 1537515 
- 1567515 
-  12



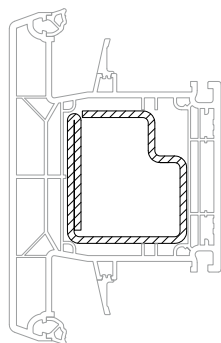

45 x 50

	<b>1357545</b>
	2
lx	11,1
ly	13,1
	6



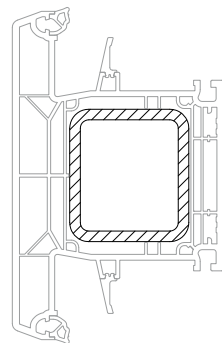

45 x 50

	<b>1357546</b>
	2,5
lx	14,1
ly	15,4
	6



45 x 50

	<b>1357553@</b>
	4
lx	18,6
ly	22
	6

Flügel

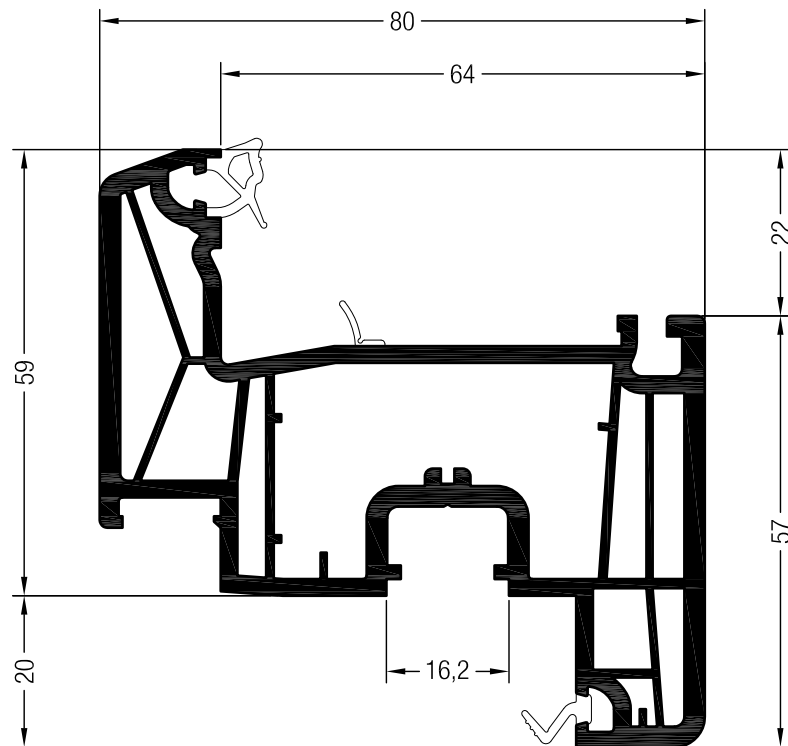

Flügel Z 59 SYNEGO®

- 1537215
- 1567215
- 24

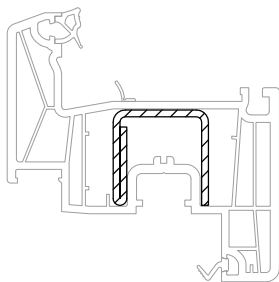

28 x 28

	<b>1313130</b>	
	2	
lx	2,5	
ly	1,6	
	6	

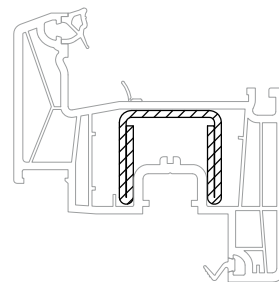

30 x 28

	<b>1306617</b>	
	2	
lx	3,7	
ly	1,9	
	6	

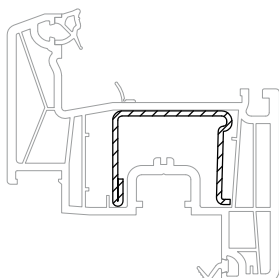

35 x 28

	<b>1244516</b>	<b>1244526</b>
	1,5	2
lx	2,7	3,5
ly	1,3	1,7
	6	6

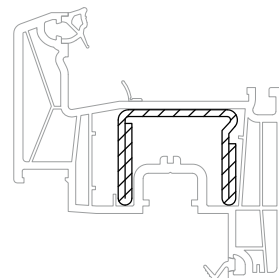

35 x 28

	<b>1244536</b>	
	2	
lx	5	
ly	2	
	6	

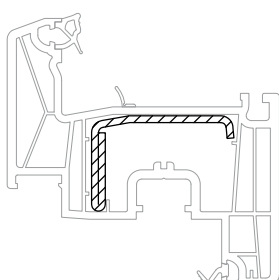

41,8 x 28

	<b>1352515</b>	
	2	
lx	3,3	
ly	1,4	
	6	

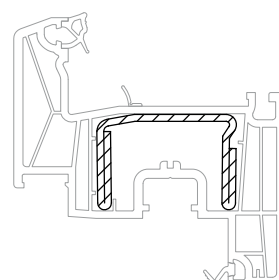

41 x 28

	<b>1352512</b>	
	2	
lx	7,1	
ly	2,1	
	6	

**Flügel**

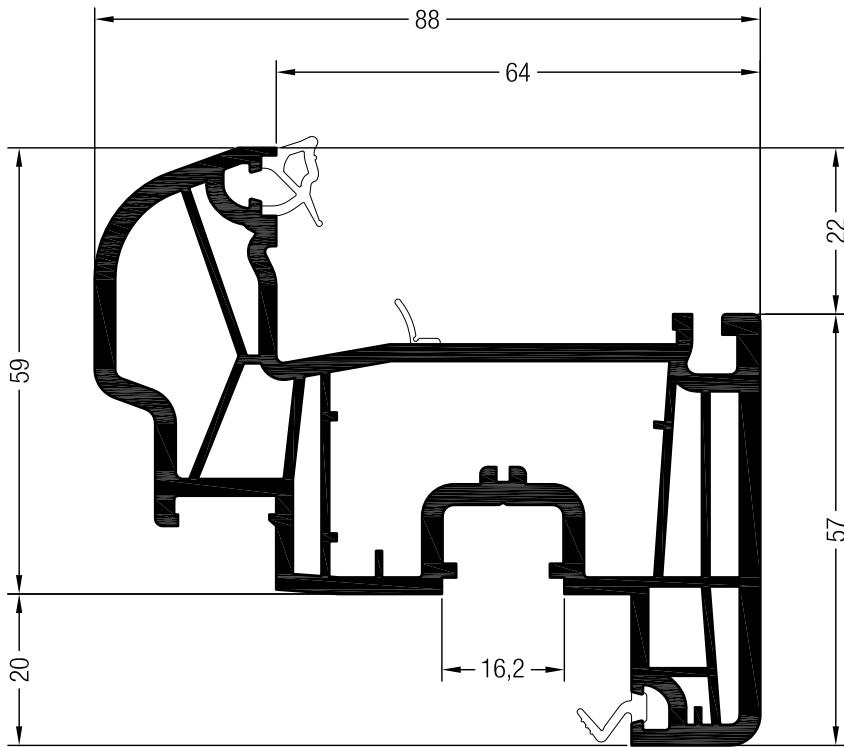

Flügel 59 rund SYNEGO®

- 1537245
- 1567245
- 24

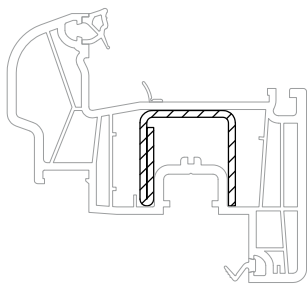

28 x 28

	<b>1313130</b>	
	2	
lx	2,5	
ly	1,6	
	6	

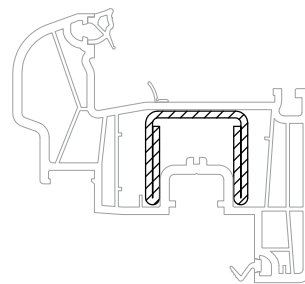

30 x 28

	<b>1306617</b>	
	2	
lx	3,7	
ly	1,9	
	6	

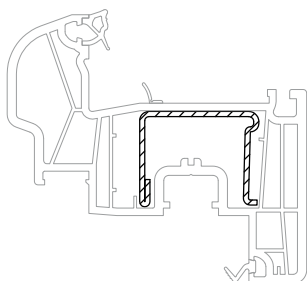

35 x 28

	<b>1244516</b>	<b>1244526</b>
	1,5	2
lx	2,7	3,5
ly	1,3	1,7
	6	6

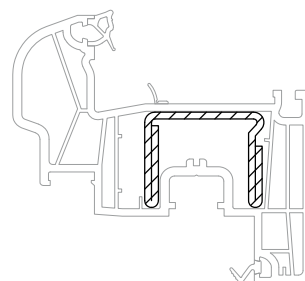

35 x 28

	<b>1244536</b>	
	2	
lx	5	
ly	2	
	6	

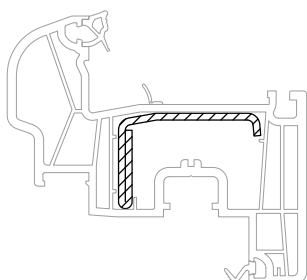

41,8 x 28

	<b>1352515</b>	
	2	
lx	3,3	
ly	1,4	
	6	

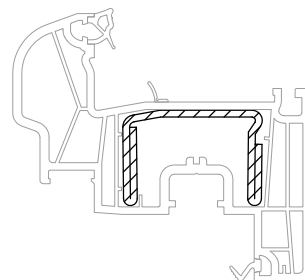

41 x 28

	<b>1352512</b>	
	2	
lx	7,1	
ly	2,1	
	6	

**Flügel**

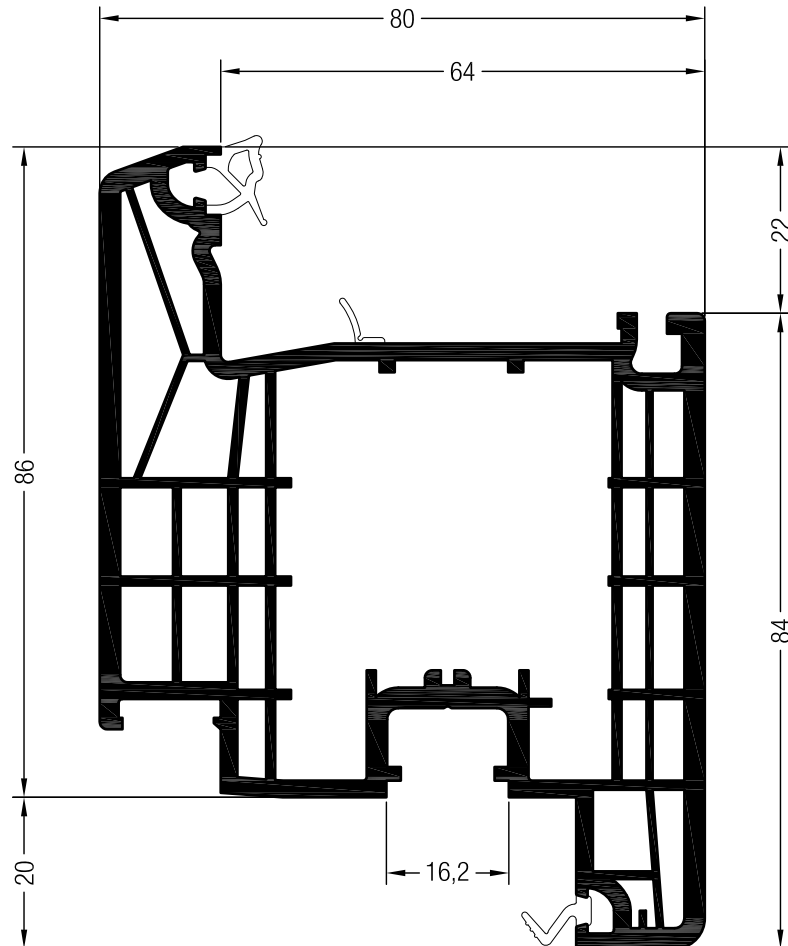

Flügel Z 86 SYNEGO®

- 1537235
- 1567235
- 12

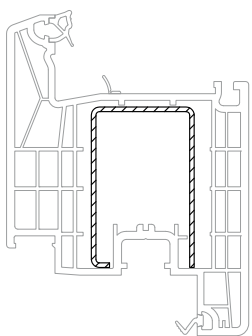

34 x 53

	<b>1357547</b>
	1,5
lx	4,6
ly	6,5
	6

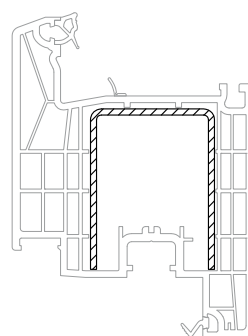

41 x 53

	<b>1357548</b>
	2
lx	8,7
ly	8,4
	6

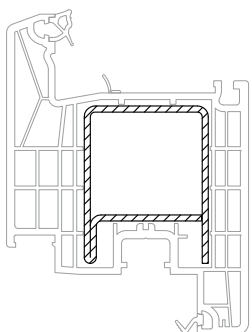

41 x 52

	<b>1357555</b>
	2
lx	10,1
ly	10,8
	6

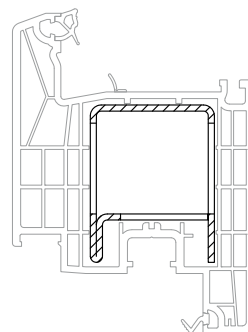

41 x 52

	<b>1357557</b>	<b>1357558</b>
	2	2
	DIN links	DIN rechts
	konfektioniert für Schlossseite	
	2,2	2,2

Flügel

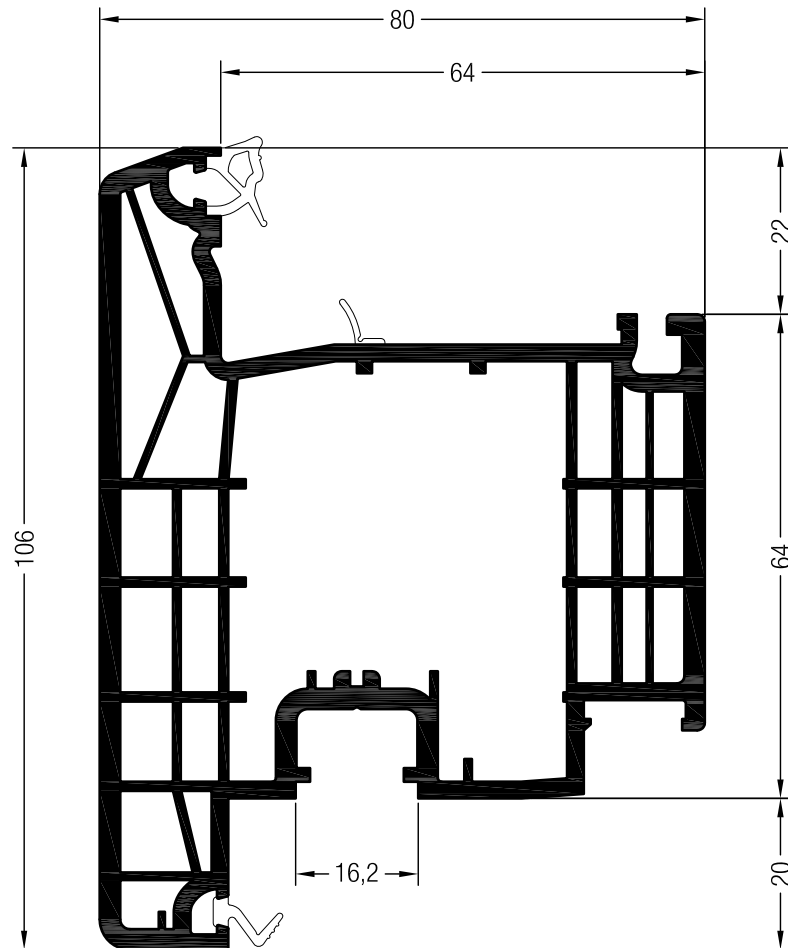

Flügel T 106 SYNEGO®

- 1537315
- 1567315
- 12

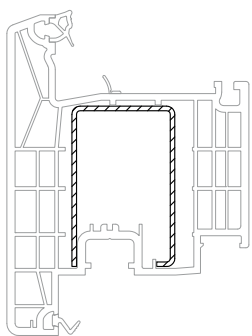

34 x 53

	<b>1357547</b>
	1,5
lx	4,6
ly	6,5
	6

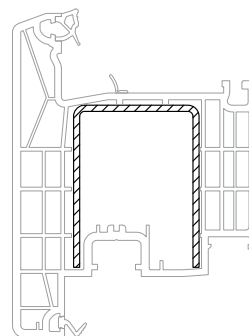

41 x 53

	<b>1357548</b>
	2
lx	8,7
ly	8,4
	6

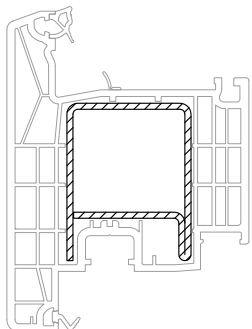

41 x 52

	<b>1357555</b>
	2
lx	10,1
ly	10,8
	6

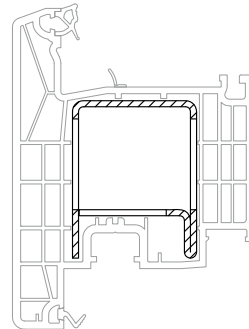

41 x 52

	<b>1357557</b>	<b>1357558</b>
	2	2
	DIN links	DIN rechts
konfektioniert für Schlossseite		
	2,2	2,2



**Flügel**

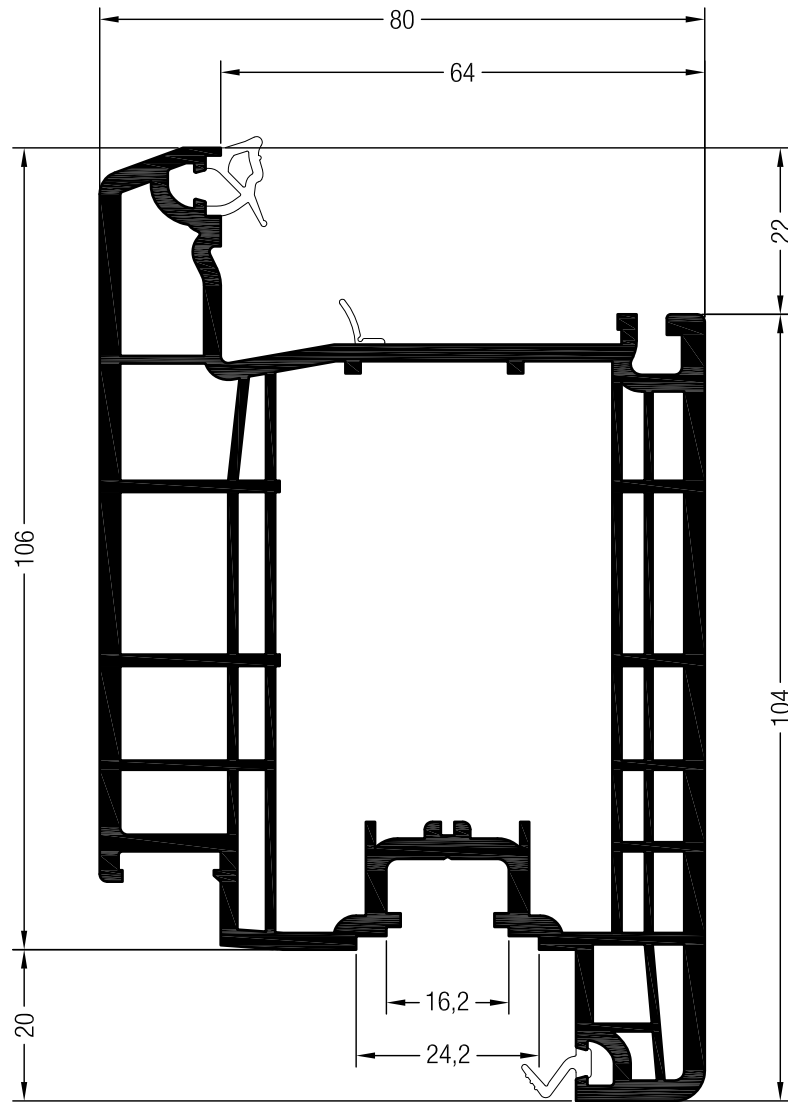

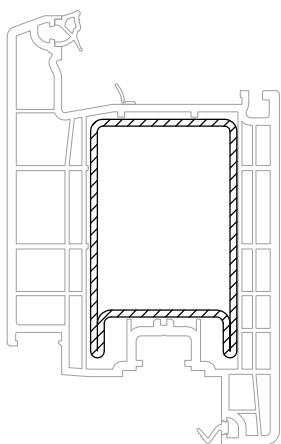

Haustürflügel Z SYNEGO®

- 1537295  
- 1567295  
-  13



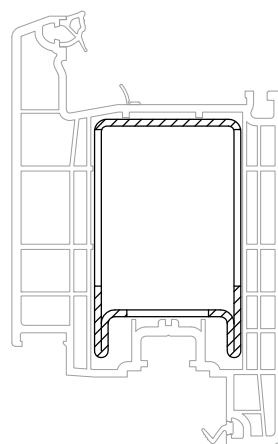

43 x 70

	<b>1357549</b>
	2
lx	14,9
ly	27,1
	6



43 x 70

	<b>1357556</b>
	2
konfektioniert für Schlosseite	
	2,4

Flügel

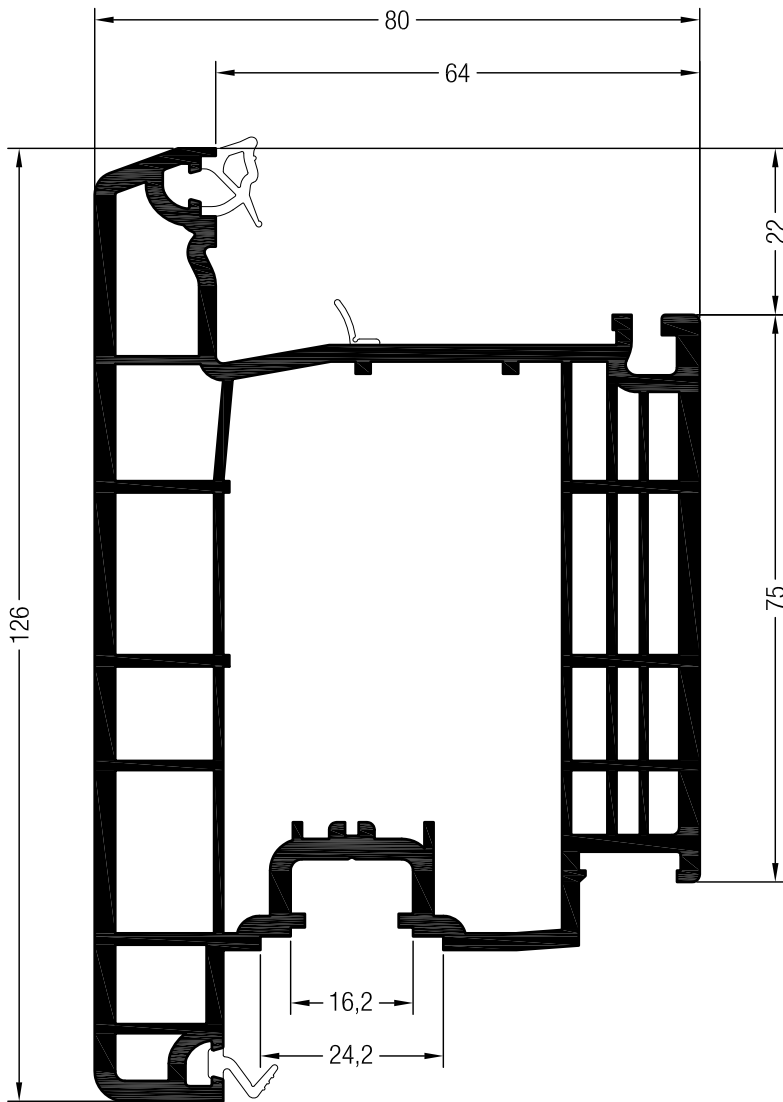

Haustürflügel T SYNEGO®

- 1537305
- 1567305
- 13

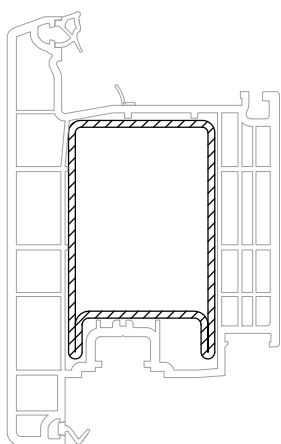

43 x 70

	<b>1357549</b>
	2
lx	14,9
ly	27,1
	6

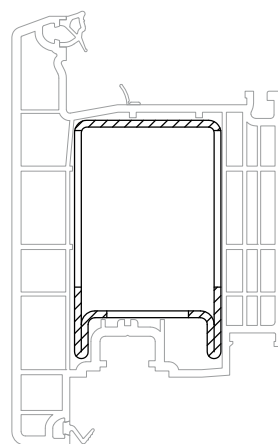



43 x 70

	<b>1357556</b>
	2
konfektioniert für Schlossseite	
	2,4

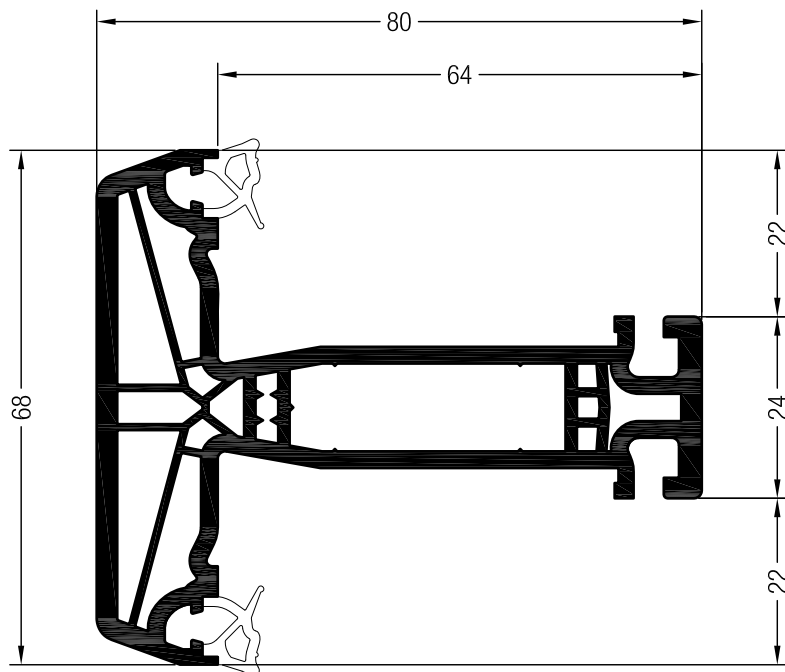
**Flügelprossen**



Sprosse 68 SYNEGO®



1537425   

1567425   

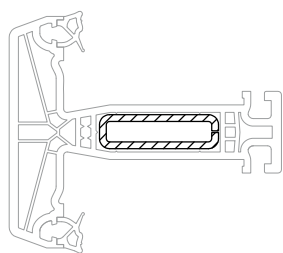
 36



35 x 10

	<b>1261801</b>
	2
lx	1,8
ly	0,22
	6

Profile für mehrflügelige Fenster ohne festen Pfosten

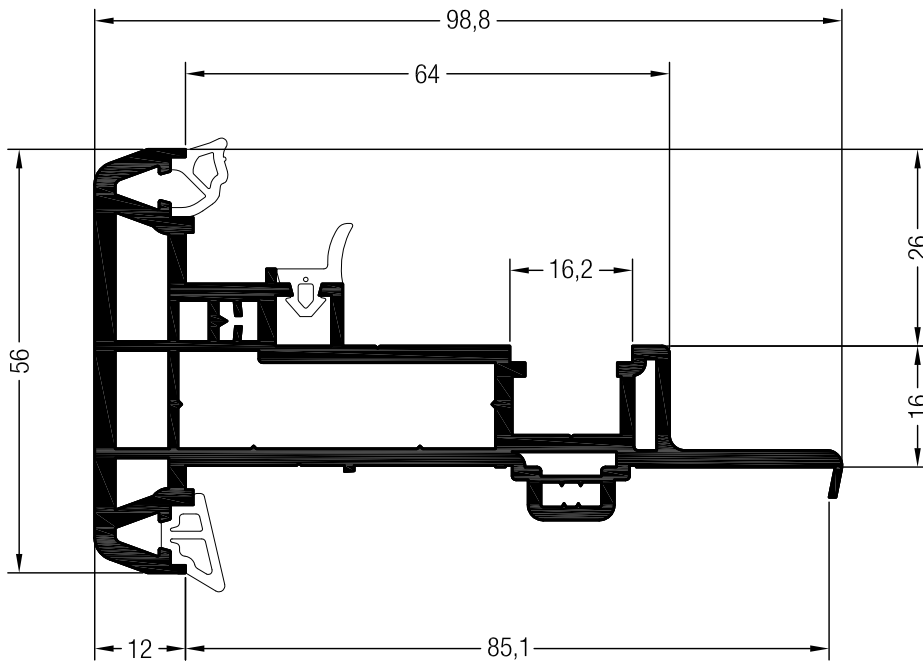

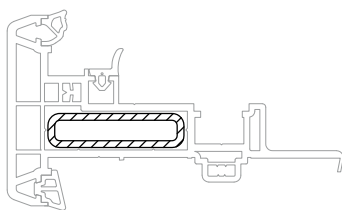

Stulpprofil SYNEGO®

- 1537445   
- 1567445   
-  24



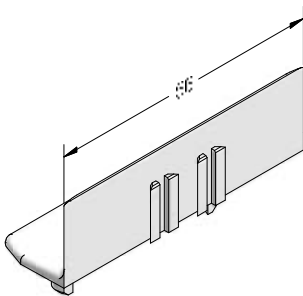

40 x 10

	1247898
	2
lx	2,7
ly	0,25
	6



Endkappe Stulpprofil außen SYNEGO®

ASA





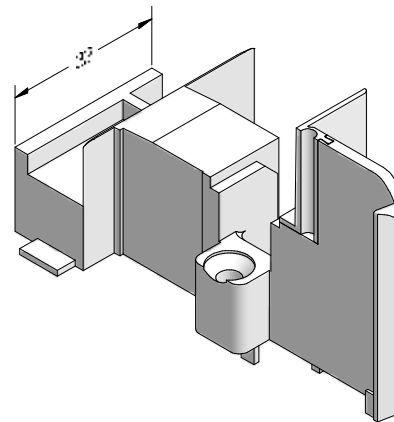



- 1358024   

 50



Endkappe Stulpprofil innen SYNEGO®

ASA/TPE

- 1358026    
- 1358027    

 50

Profile für mehrflügelige Fenster ohne festen Pfosten

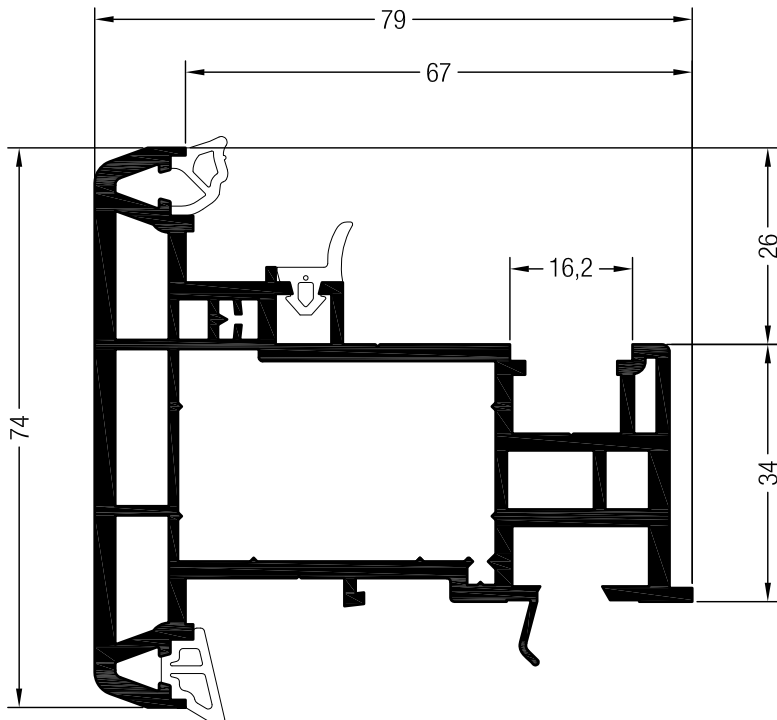

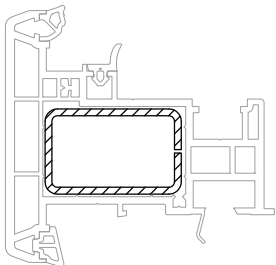

Blindpfosten SYNEGO®

- 1537455  
- 1567455  
-  24



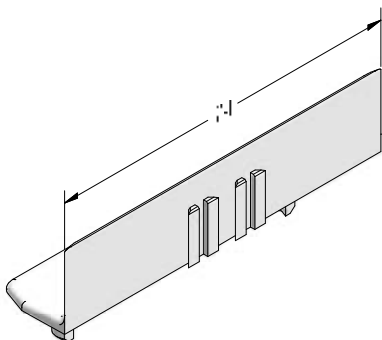

40 x 25

	1357552
	2
lx	4,8
ly	2,3
	6



Endkappe Blindpfosten außen SYNEGO®

ASA



- 1358034   

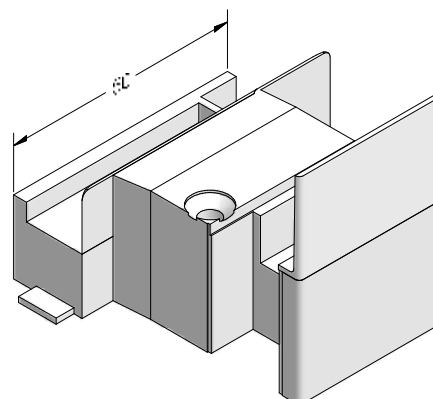

 50



Endkappe Blindpfosten innen SYNEGO®

ASA/TPE

- 1358036   

1358037   

 50

Profile für mehrflügelige Fenster ohne festen Pfosten

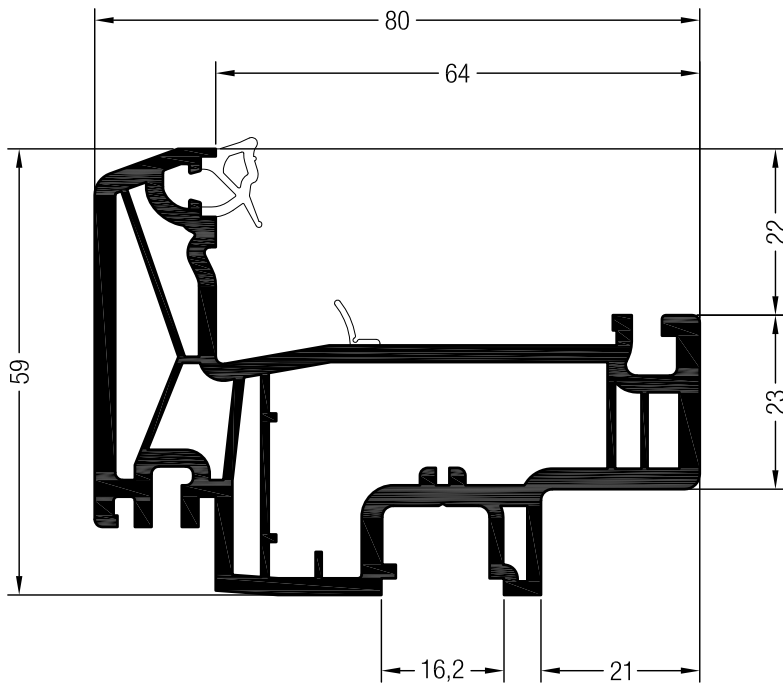

Stulpflügel Z 59 SYNEGO®

1537485

1567485

24

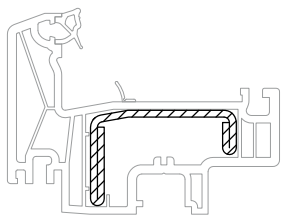

42,8 x 28

	<b>1357554</b>
	2
lx	5,6
ly	1,4
	6

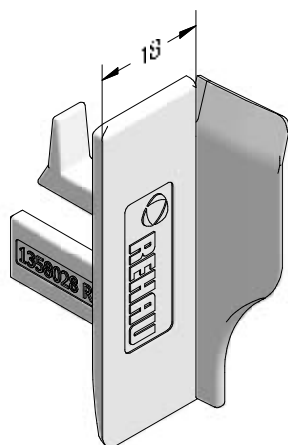

Endkappe Stulpflügel SYNEGO®

TPE

1358028

1358029

50

Profile für mehrflügelige Fenster ohne festen Pfosten

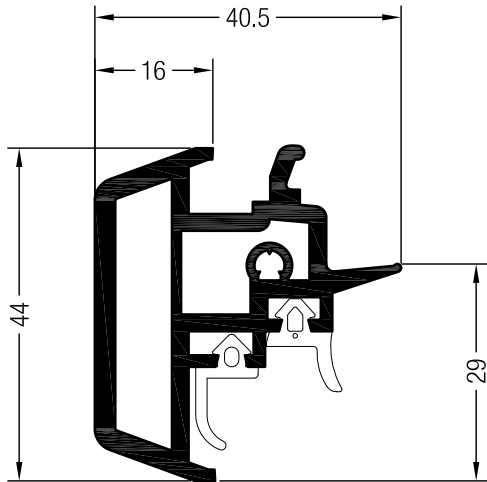

Stulpleiste SYNEGO®

- 1537495
- 1567495
- 36

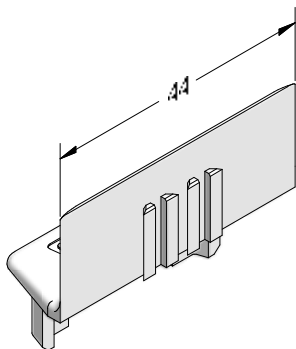

Endkappe Stulpleiste außen SYNEGO®

ASA

- 1358110
- 50

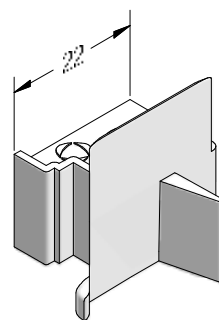

Endkappe Stulpleiste innen SYNEGO®



ASA

- 1358038
- 1358039
- 50

**MASTERVORLAGE**  
 ist den landesspezifischen Vorgaben  
 anzupassen. Stand 10.2014

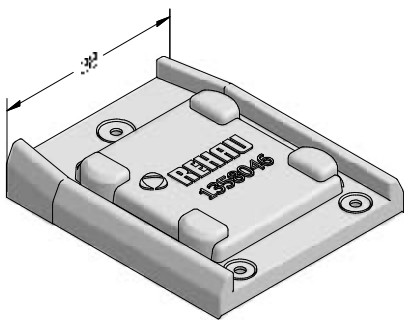
**Zubehör für mechanische Verbindungen**



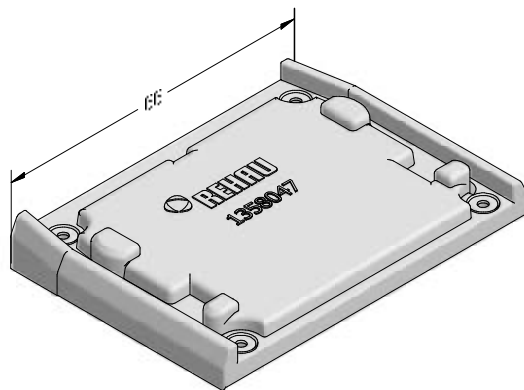

Mechanischer Verbinder Pfosten 96 AD SYNEGO®  
 TPE  
**1358046**     
 50



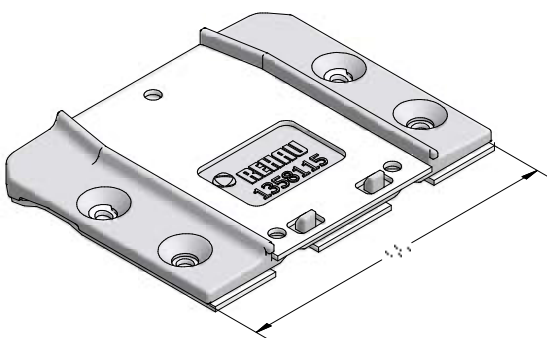

Mechanischer Verbinder Pfosten 124 AD SYNEGO®  
 TPE  
**1358047**     
 50

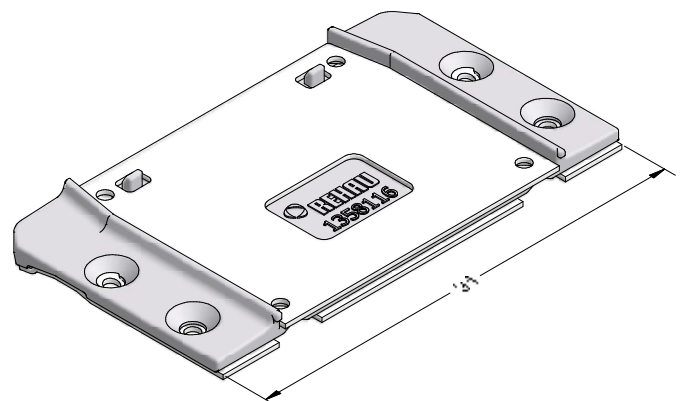

Mechanischer Verbinder Pfosten 96 AD SYNEGO®  
 Zink-Druckguss  
**1358115**   
 50



Mechanischer Verbinder Pfosten 124 AD SYNEGO®  
 Zink-Druckguss  
**1358116**   
 50



Zubehör für mechanische Verbindungen

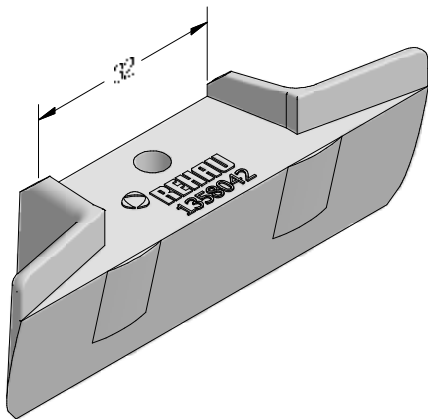

Dichtblock Pfosten 96 MD SYNEGO®  
TPE  
**1358042** ■ ■  
 50

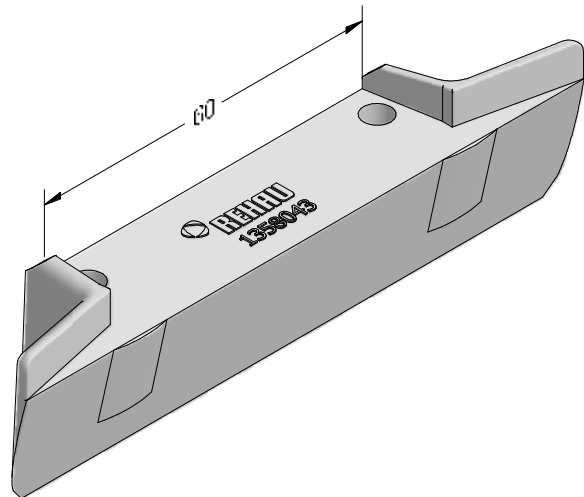

Dichtblock Pfosten 124 MD SYNEGO®  
TPE  
**1358043** ■ ■  
 50

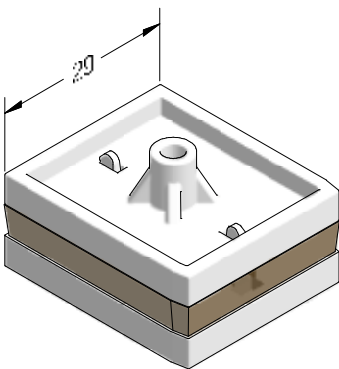

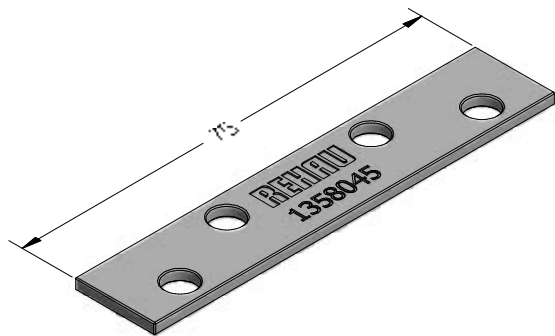

Dichtteil Pfosten 96 MD SYNEGO®  
PA/TPE  
**1358058** ■  
 50



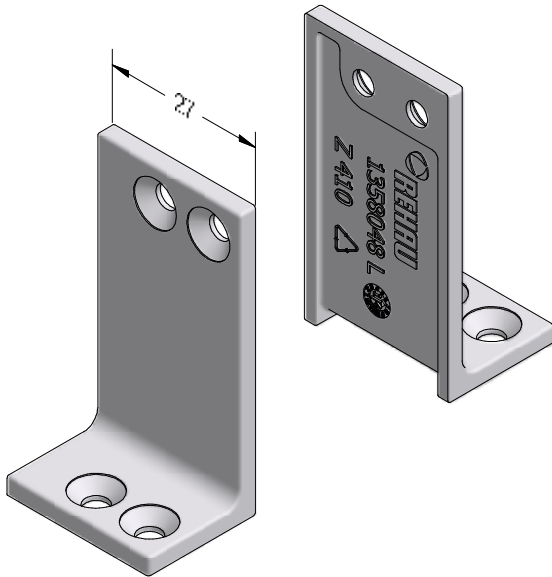

Montageplatte Pfosten 96 und 124 SYNEGO®  
Stahl verzinkt  
**1358045** ■  
 400

Zubehör für mechanische Verbindungen

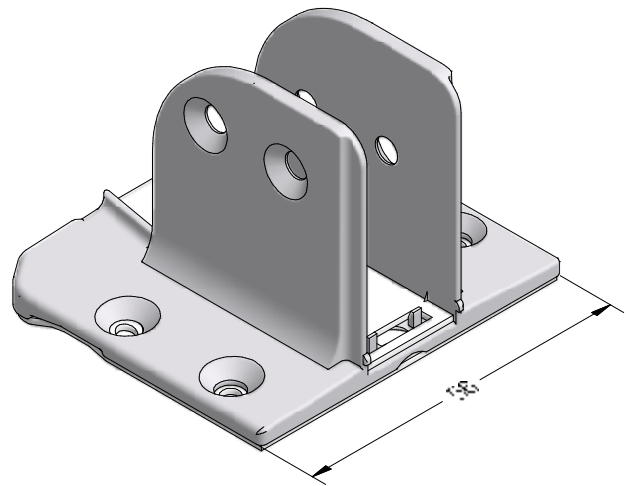

Set Pfostenwinkel Kreuzstoß Pfosten MD SYNEGO®  
Zink-Druckguss  
**1358048**   
 20



Mechanischer Verbinder Sprosse 68 SYNEGO®  
Zink-Druckguss  
**1358044**   
 50

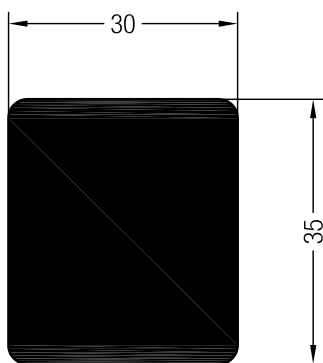

Mechanischer Verbinder universal Pfosten 96 SYNEGO®  
30 x 35  
**1358033**   
 2

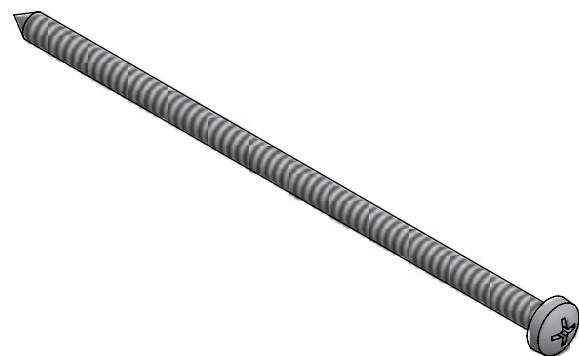

Blechschaube ISO 7049, 4,2 x 100  
Stahl verzinkt  
**1247725**  
 200

Blechschaube ISO 7049, 4,2 x 120  
Stahl verzinkt  
**1207679**  
 100

**Bodenschwelle und Zubehör**

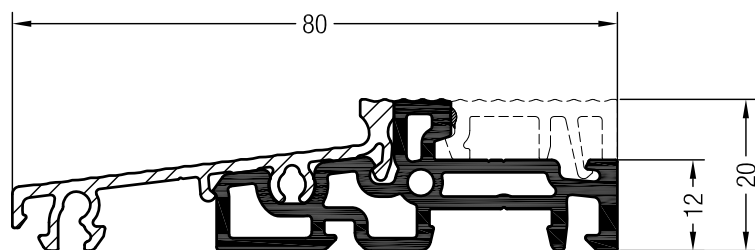
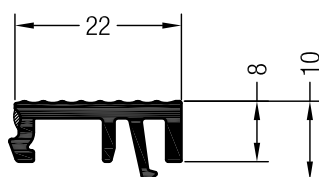

Set Bodenschwelle Bautiefe 80

**1356663** 

 6

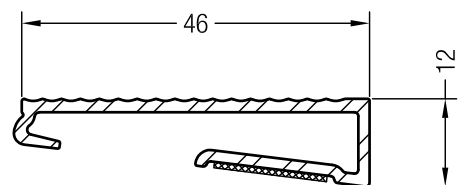

Deckelprofil auswärts öffnend Bautiefe 80



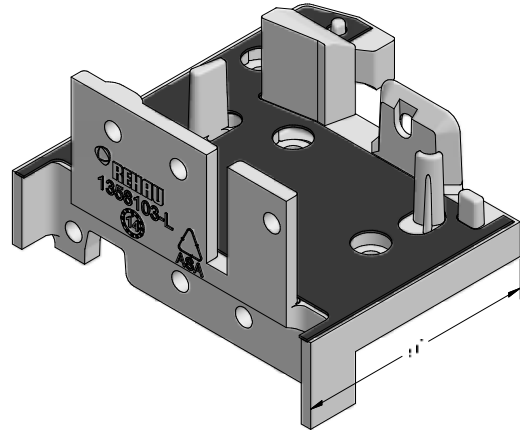
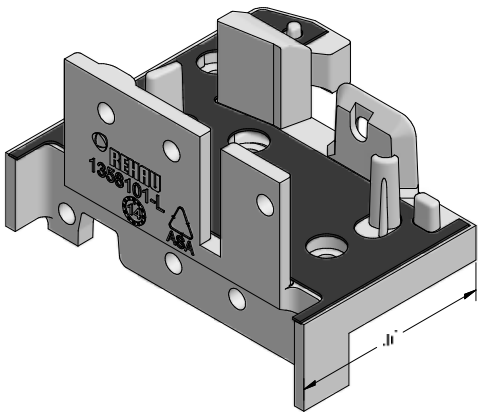

**1356673** 

 6

**Bodenschwelle und Zubehör**



Schwellenhalter Blendrahmen 72 SYNEGO®

- ASA  
**1358100**    
**1358101**    
 50

Schwellenhalter Blendrahmen 82 SYNEGO®

- ASA  
**1358102**    
**1358103**    
 50

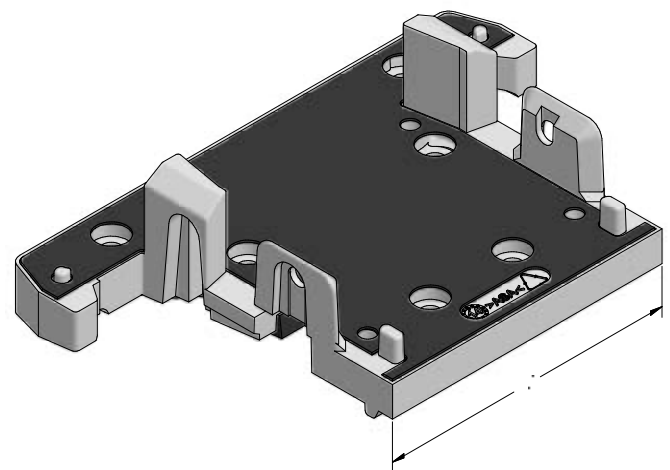
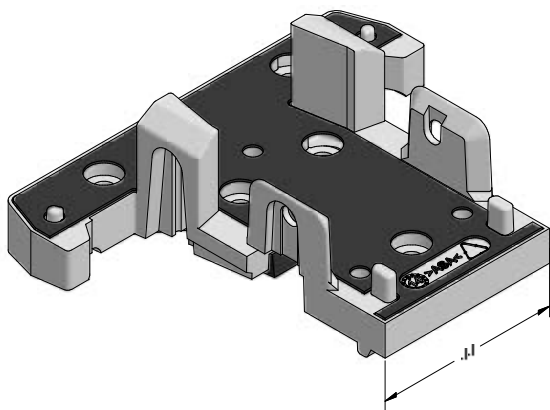

Schwellenhalter Pfosten 96 SYNEGO®

- ASA  
**1358104**   
 50

Schwellenhalter Pfosten 124 SYNEGO®

- ASA  
**1358105**   
 50

**Bodenschwelle und Zubehör**

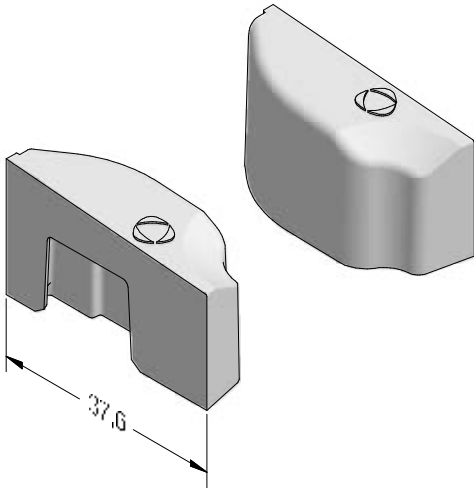

Set Windstopp AD SYNEGO®

TPE

**1358108** ■

25

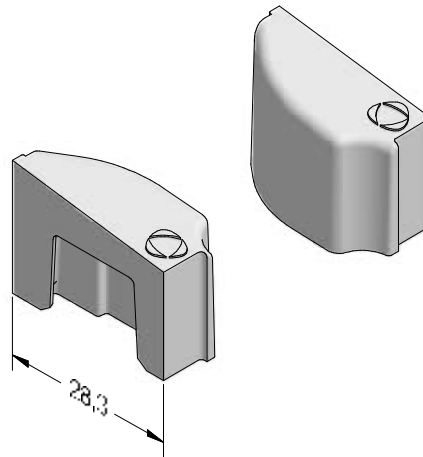

Set Windstopp MD SYNEGO®

TPE

**1358109** ■

25

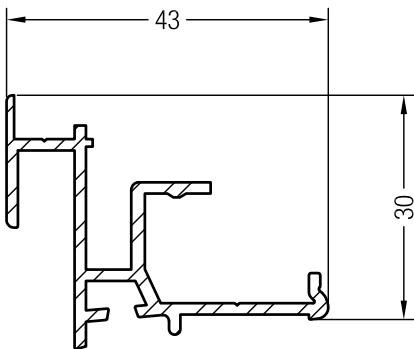

Ausgleichsprofil SYNEGO®

**1357344** ▨

6

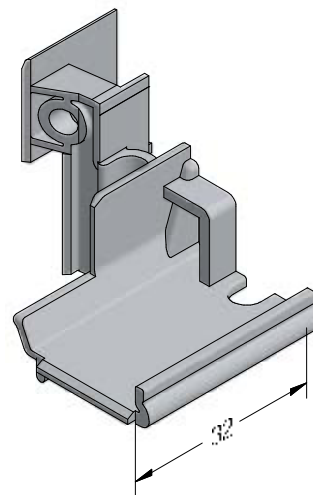

Endkappe Ausgleichsprofil SYNEGO®

ASA

**1358056** ↶ ■

**1358057** ↷ ■

50

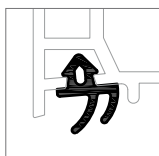

■	<b>1865530</b>
■	<b>1864952</b>

**Bodenschwelle und Zubehör**

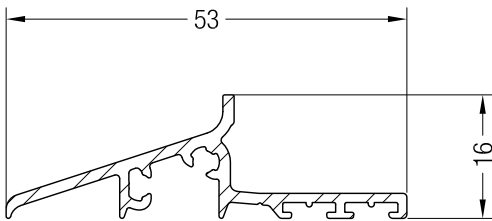



Wetterschenkel SYNEGO®

**1357341** 

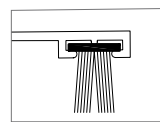
 6





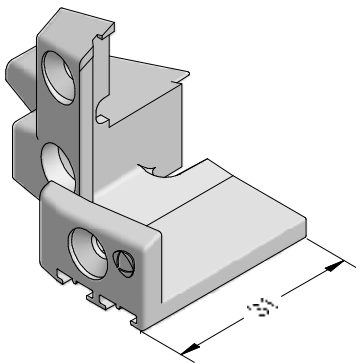

	<b>1248095</b>
	50



Endkappe Wetterschenkel SYNEGO®

ASA

**1358052**  

**1358053**  

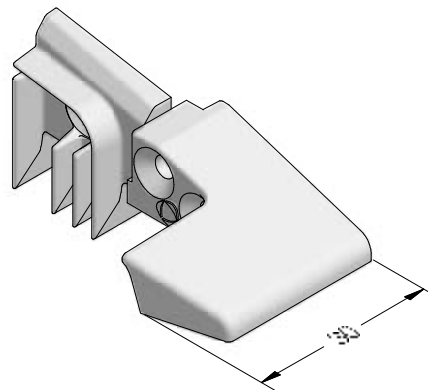

 50



Endkappe Wetterschenkel Stulp SYNEGO®

ASA

**1358054**  

**1358055**  

 50

**Bodenschwelle und Zubehör**

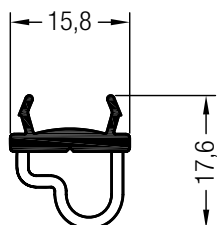

Kältestopp

**1353383**

6

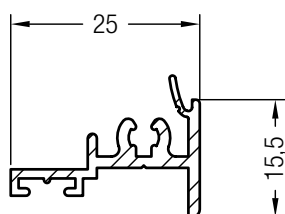

Deckleiste Flügel T SYNEGO®

**1353550**

6

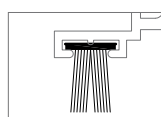

	<b>1248095</b>
	50

**Zubehör auswärts öffnende Elemente**

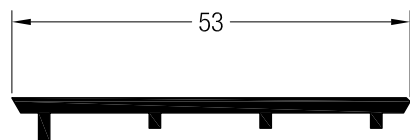

Falzeinlageprofil SYNEGO®

**1537340** @ @

72

Zubehör für Haus- und Nebeneingangstüren

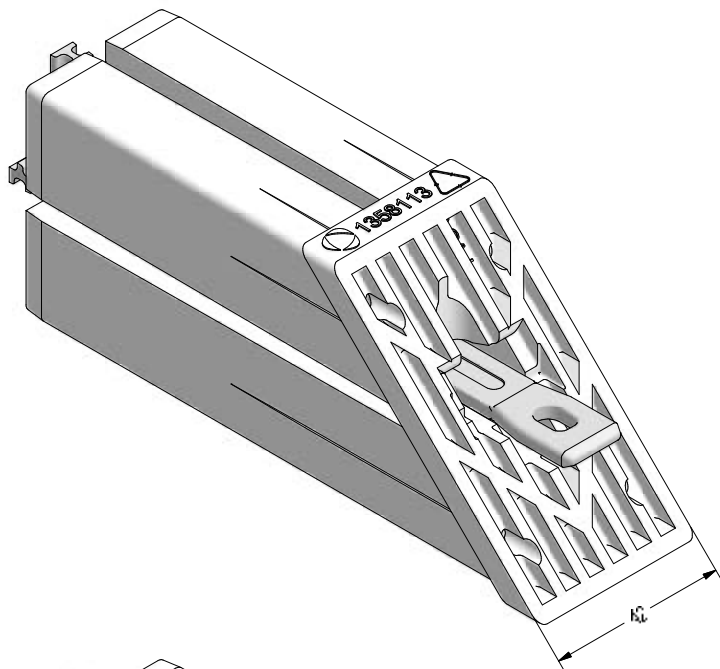

Schweißbarer Eckverbinder HT-Flügel SYNEGO®

PVC-U

**1358113** 

 96

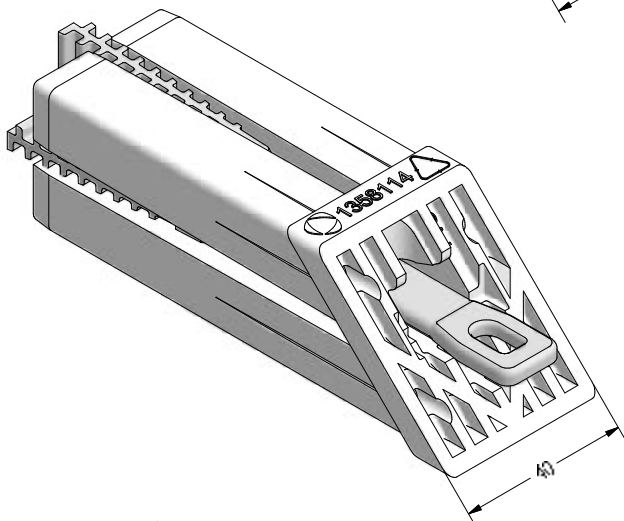

Schweißbarer Eckverbinder Flügel 86/106 SYNEGO®

PVC-U

**1358114** 

 96



Spannhebel

Zink-Druckguss

**1353616** 

 1



**Bohrlehren**

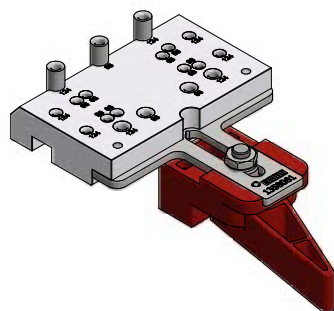

Bohrlehre mech. Verbinder Pfosten/Sprosse AD SYNEGO®  
(Bohrlehre für Blendrahmen SYNEGO® AD,  
Bohrlehre für Pfosten SYNEGO® AD in Verbindung mit Kreuzstoß,  
Bohrlehre Flügel SYNEGO® in Verbindung mit Sprosse 68 SYNEGO®)

**1358061**



1

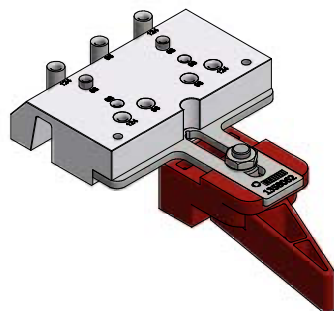

Bohrlehre mech. Verbinder Pfosten/Sprosse MD SYNEGO®  
(Bohrlehre für Blendrahmen SYNEGO® MD,  
Bohrlehre für Flügel SYNEGO® in Verbindung mit Sprosse 68 SYNEGO®)

**1358062**



1

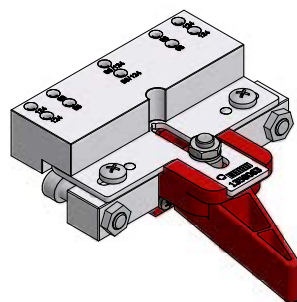

Bohrlehre mech. Verbinder Pfostenwinkel SYNEGO®  
(Bohrlehre für Pfosten SYNEGO® MD in Verbindung mit Kreuzstoß)

**1358063**



1

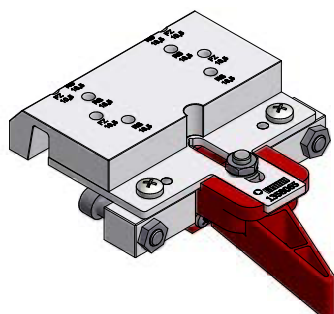

Bohrlehre Schwellenhalter SYNEGO®  
(Bohrlehre für Blendrahmen und Pfosten SYNEGO® AD/MD)

**1358065**



1

**Armierungen**

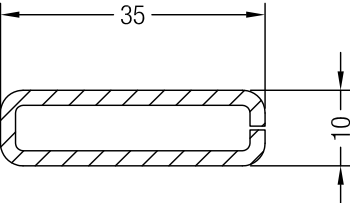
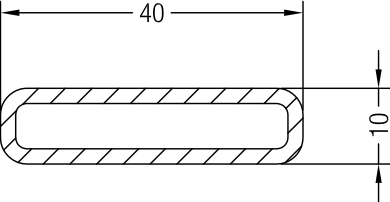
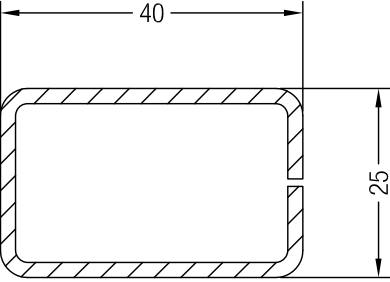
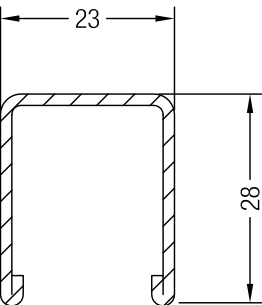
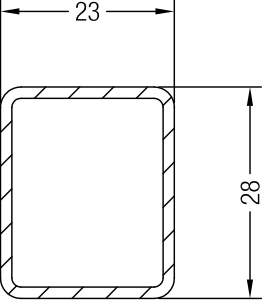
	Art.-Nr.		lx	ly
	<b>1261801</b>	2	1,8	0,22
	<b>1247898</b>	2	2,7	0,25
	<b>1357552</b>	2	4,8	2,3
	<b>1306619</b>	1,5	1,1	1,1
	<b>1357540</b>	1,5	1,1	1,5

**Armierungen**

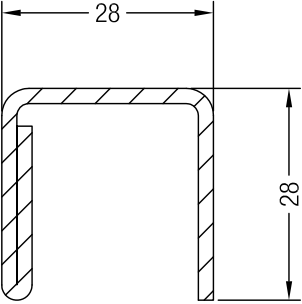
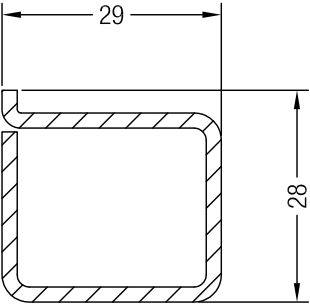
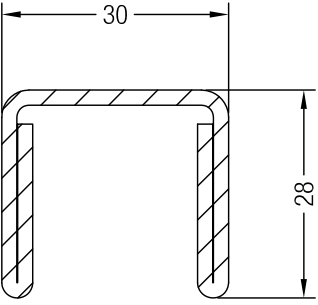
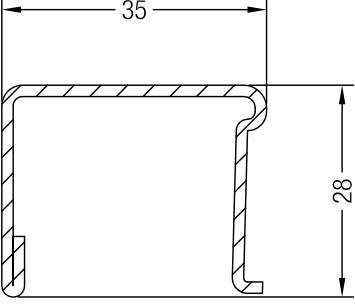
	Art.-Nr.		lx	ly
	<b>1313130</b>	2	2,5	1,6
	<b>1357550</b>	2	2,3	1,8
	<b>1306617</b>	2	3,7	1,9
	<b>1244516</b>	1,5	2,7	1,3
	<b>1244526</b>	2	3,5	1,7

**Armierungen**

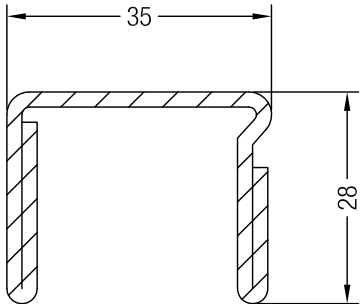
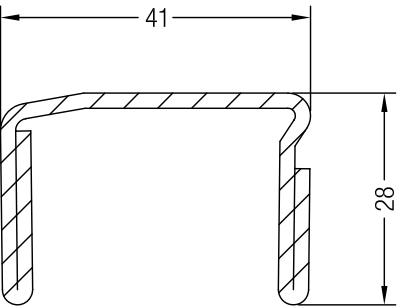
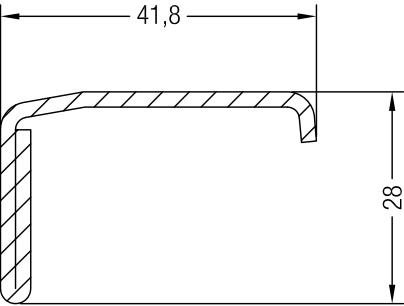
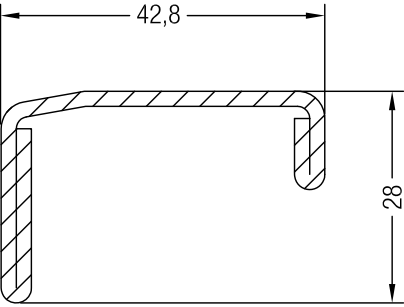
	Art.-Nr.		lx	ly
	<b>1244536</b>	2	5	2
	<b>1352512</b>	2	7,1	2,1
	<b>1352515</b>	2	3,3	1,4
	<b>1357554</b>	2	5,6	1,4

**Armierungen**

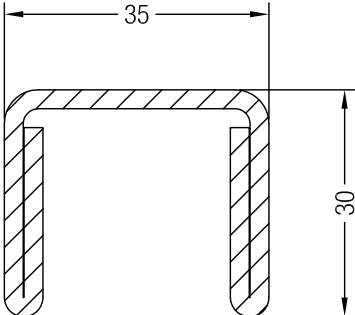
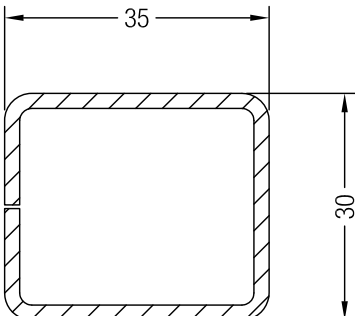
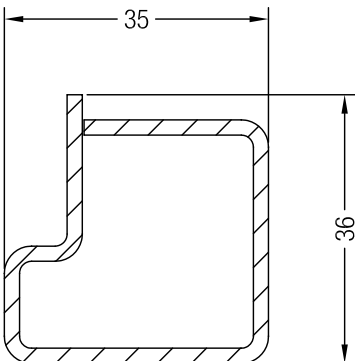
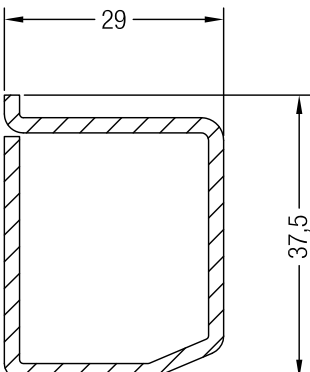
	Art.-Nr.		lx	ly
	<b>1357551</b>	2,5	6,6	2,9
	<b>1357544</b>	2	4	3,1
	<b>1357543</b>	2	3,6	3,7
	<b>1357559</b>	2	2,9	3,9

**Armierungen**

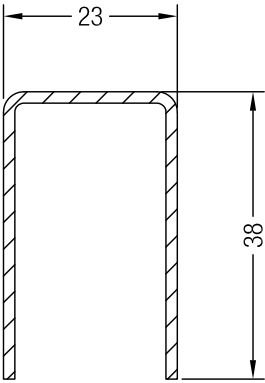
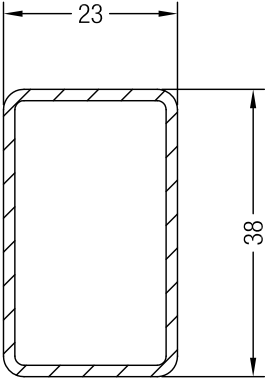
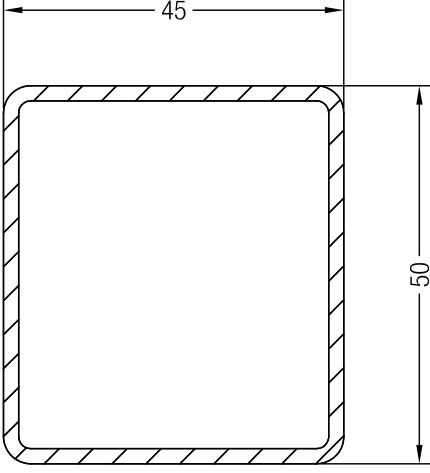
	Art.-Nr.		lx	ly
	<b>1357541</b>	1,5	1,4	2,1
	<b>1357542</b>	1,5	1,5	3,2
	<b>1357545</b>	2	11,1	13,1

**Armierungen**

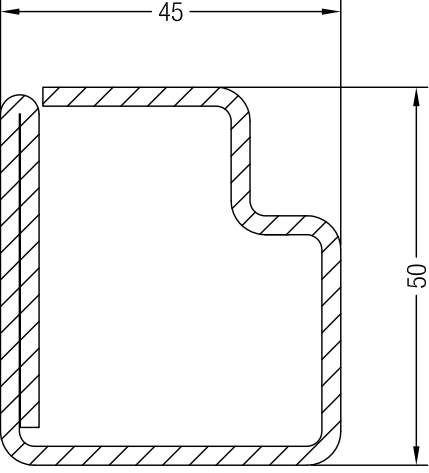
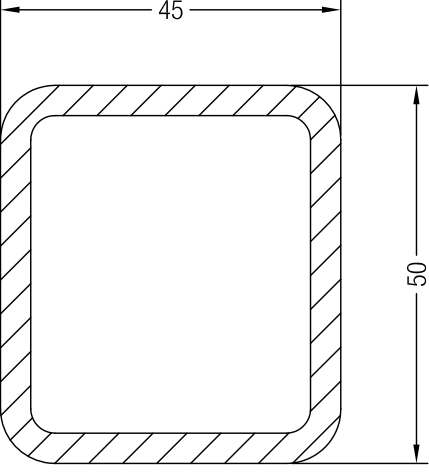
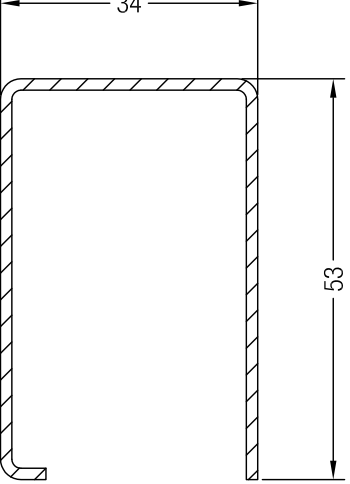
	Art.-Nr.		lx	ly
	<b>1357546</b>	2,5	14,1	15,4
	<b>1357553@</b>	4	18,6	22
	<b>1357547</b>	1,5	4,6	6,5

**Armierungen**

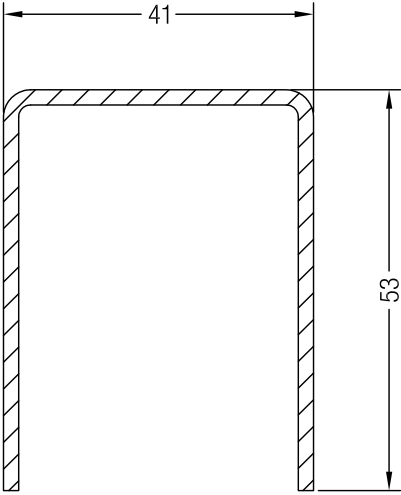
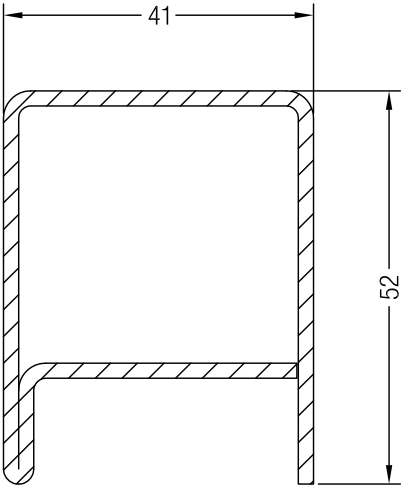
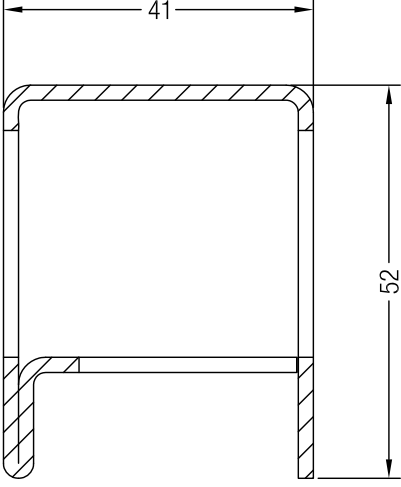
	Art.-Nr.		lx	ly
	<b>1357548</b>	2	8,7	8,4
	<b>1357555</b>	2	10,1	10,8
	<b>1357557</b> <b>DIN links</b> <b>1357558</b> <b>DIN rechts</b>	2	vorkonfektioniert für Schlosseite	

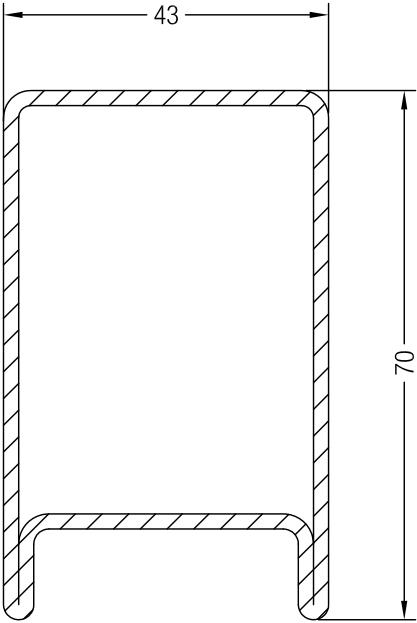
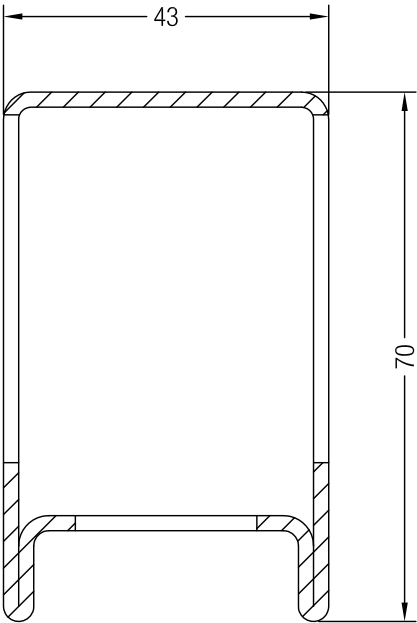

**Armierungen**

	Art.-Nr.		lx	ly
	<b>1357549</b>	2	14,9	27,1
	<b>1357556</b>	2	vorkonfektioniert für Schlosseite	

**Artikelverzeichnis**

Art.-Nr.	Bezeichnung	Pack/ Bündel in m	Langgutpalette in m		Karton/ Beutel in Stück	Seite
			Pack	Schrumpf		
1207679	Schraube 4,2 x 120				100	24
1244516	Armierung 35 x 28 x 1,5	6/504				33
1244526	Armierung 35 x 28 x 2	6/504				33
1244536	Armierung 35 x 28 x 2	6/504				34
1247725	Schraube 4,2 x 100				200	24
1247898	Armierung 40 x 10 x 2	6/300				32
1248095	Bürstendichtung 6,7 x 9				50	28
1261801	Armierung 35 x 10 x 2	6/300				32
1306617	Armierung 30 x 28 x 2	6/300				33
1306619	Armierung 23 x 28 x 1,5	6/300				32
1313130	Armierung 28 x 28 x 2	6/300				33
1352512	Armierung 41 x 28 x 2	6/300				34
1352515	Armierung 41,8 x 28 x 2	6/384				34
1353383	Kältestopp	6				29
1353550	Deckleiste Flügel T SYNEGO®	6				29
1353616	Spannhebel	1				30
1356663	Set Bodenschwelle Bautiefe 80	6				25
1356673	Deckelprofil außenöffnend Bautiefe 80	6				25
1357341	Wetterschenkel SYNEGO®	6				28
1357344	Ausgleichsprofil SYNEGO®	6				27
1357540	Armierung 23 x 28 x 1,5	6/300				32
1357541	Armierung 23 x 38 x 1,5	6/300				36
1357542	Armierung 23 x 38 x 1,5	6/300				36
1357543	G-Armierung 35 x 36 x 2	6/300				35
1357544	Armierung 35 x 30 x 2	6/300				35
1357545	Armierung 45 x 50 x 2	6/300				36
1357546	G-Armierung 45 x 50 x 2,5	6/300				37
1357547	Armierung 34 x 53 x 1,5	6/300				37
1357548	Armierung 41 x 53 x 2	6/300				38
1357549	Armierung 43 x 70 x 2	6/300				39
1357550	Armierung 29 x 28 x 2	6/300				33
1357551	Armierung 35 x 30 x 2,5	6/300				35
1357552	Armierung 40 x 25 x 2	6/300				32
1357553@	Armierung 45 x 50 x 4	6/300				37
1357554	Armierung 42,8 x 28	6/300				34
1357555	Armierung 41 x 52 x 2	6/300				38
1357556	Armierung 43 x 70 x 2, konfektioniert	2,4				39
1357557	Armierung 41 x 52 x 2, konfektioniert (DIN links)	2,2				38
1357558	Armierung 41 x 52 x 2, konfektioniert (DIN rechts)	2,2				38
1357559	Armierung 29 x 37,5 x 2	6/300				35
1358024	Endkappe Stulpprofil außen SYNEGO®				50	18

**Artikelverzeichnis**

Art.-Nr.	Bezeichnung	Pack/ Bündel in m	Langgutpalette in m		Karton/ Beutel in Stück	Seite
			Pack	Schrumpf		
1358026	Endkappe Stulpprofil innen SYNEGO® (rechts)				50	18
1358027	Endkappe Stulpprofil innen SYNEGO® (links)				50	18
1358028	Endkappe Stulpflügel SYNEGO® (rechts)				50	20
1358029	Endkappe Stulpflügel SYNEGO® (links)				50	20
1358033	Mechanischer Verbinder universal Pfosten 96 SYNEGO®	2				24
1358034	Endkappe Blindpfosten außen SYNEGO®				50	19
1358036	Endkappe Blindpfosten innen SYNEGO® (rechts)				50	19
1358037	Endkappe Blindpfosten innen SYNEGO® (links)				50	19
1358038	Endkappe Stulpleiste innen SYNEGO® (rechts)				50	21
1358039	Endkappe Stulpleiste innen SYNEGO® (links)				50	21
1358042	Dichtblock Pfosten 96 MD SYNEGO®				50	23
1358043	Dichtblock Pfosten 124 MD SYNEGO®				50	23
1358044	Mechanischer Verbinder Sprosse 68 SYNEGO®				50	24
1358045	Montageplatte Pfosten 96 nd 124 SYNEGO®				400	23
1358046	Mechanischer Verbinder Pfosten 96 AD SYNEGO®				50	22
1358047	Mechanischer Verbinder Pfosten 124 AD SYNEGO®				50	22
1358048	Set Pfostenwinkel SYNEGO®				20	24
1358052	Endkappe Wetterschenkel SYNEGO® (rechts)				50	28
1358053	Endkappe Wetterschenkel SYNEGO® (links)				50	28
1358054	Endkappe Wetterschenkel Stulp SYNEGO® (rechts)				50	28
1358055	Endkappe Wetterschenkel Stulp SYNEGO® (links)				50	28
1358056	Endkappe Ausgleichsprofil SYNEGO® (rechts)				50	27
1358057	Endkappe Ausgleichsprofil SYNEGO® (links)				50	27
1358058	Dichtteil Pfosten 96 MD SYNEGO®				50	23
1358061	Bohrlehre mech. Verbinder Pfosten/Sprosse AD SYNEGO®				1	31
1358062	Bohrlehre mech. Verbinder Pfosten/Sprosse MD SYNEGO®				1	31
1358063	Bohrlehre mech. Verbinder Pfostenwinkel SYNEGO®				1	31
1358065	Bohrlehre Schwellenhalter SYNEGO®				1	31
1358100	Schwellenhalter Blendrahmen 72 SYNEGO® (rechts)				50	26
1358101	Schwellenhalter Blendrahmen 72 SYNEGO® (links)				50	26
1358102	Schwellenhalter Blendrahmen 82 SYNEGO® (rechts)				50	26
1358103	Schwellenhalter Blendrahmen 82 SYNEGO® (links)				50	26
1358104	Schwellenhalter Pfosten 96 SYNEGO®				50	26
1358105	Schwellenhalter Pfosten 124 SYNEGO®				50	26
1358108	Set Windstopp AD SYNEGO®				25	27
1358109	Set Windstopp MD SYNEGO®				25	27
1358110	Endkappe Stulpleiste außen SYNEGO®				50	21
1358113	Schweißbarer Eckverbinder HT-Flügel SYNEGO®				96	30
1358114	Schweißbarer Eckverbinder Flügel 86/106 SYNEGO®				96	30
1358115	Mechanischer Verbinder Pfosten 96 SYNEGO®				50	22
1537005	Blendrahmen 72 AD SYNEGO®	24	360	396		2







**Artikelverzeichnis**

Art.-Nr.	Bezeichnung	Pack/ Bündel in m	Langgutpalette in m		Karton/ Beutel in Stück	Seite
			Pack	Schrumpf		
1537015	Blendrahmen 82 AD SYNEGO®	24	288	324		3
1537105	Blendrahmen 72 MD SYNEGO®	24	360	396		6
1537115	Blendrahmen 82 MD SYNEGO®	24	288	324		7
1537165	Blendrahmen 72/40 MD SYNEGO®	24	360			8
1537215	Flügel Z 59 SYNEGO®	24	360	396		11
1537235	Flügel Z 86 SYNEGO®	24	216	252		13
1537245	Flügel 59 rund SYNEGO®	24	360	396		12
1537295	Haustürflügel Z SYNEGO®	13	208	208		15
1537305	Haustürflügel T SYNEGO®	13	208	208		16
1537315	Flügel T 106 SYNEGO®	24	216	352		14
1537340	Falzeinlageprofil SYNEGO®	72				29
1537405	Pfosten 96 AD SYNEGO®	24	288	324		4
1537415	Pfosten 124 AD SYNEGO®	12	216			5
1537425	Sprosse 68 SYNEGO®	36	432			17
1537445	Stulpprofil SYNEGO®	24	600			18
1537455	Blindpfosten SYNEGO®	24	360			19
1537485	Stulpflügel 59 SYNEGO®	24	576			20
1537495	Stulpleiste SYNEGO®	36	1620			21
1537505	Pfosten 98 MD SYNEGO®	24	288	324		9
1537515	Pfosten 124 MD SYNEGO®	12	216			10
1567005	Blendrahmen 72 AD SYNEGO® (kaschiert)	24	360			2
1567015	Blendrahmen 82 AD SYNEGO® (kaschiert)	24	288			3
1567105	Blendrahmen 72 MD SYNEGO® (kaschiert)	24	360			6
1567115	Blendrahmen 82 MD SYNEGO® (kaschiert)	24	288			7
1567165	Blendrahmen 72/40 MD SYNEGO® (kaschiert)	24	360			8
1567215	Flügel Z 59 SYNEGO® (kaschiert)	24	360			11
1567235	Flügel Z 86 SYNEGO® (kaschiert)	24	216			13
1567245	Flügel 59 rund SYNEGO® (kaschiert)	24	360			12
1567295	Haustürflügel Z SYNEGO® (kaschiert)	13	208			15
1567305	Haustürflügel T SYNEGO® (kaschiert)	13	208			16
1567315	Flügel T 106 SYNEGO® (kaschiert)	24	216			14
1567405	Pfosten 96 AD SYNEGO® (kaschiert)	24	288			4
1567415	Pfosten 124 AD SYNEGO® (kaschiert)	12	216			5
1567425	Sprosse 68 SYNEGO® (kaschiert)	36	432			17
1567445	Stulpprofil SYNEGO® (kaschiert)	24	600			18
1567455	Blindpfosten SYNEGO® (kaschiert)	24	360			19
1567485	Stulpflügel 59 SYNEGO® (kaschiert)	24	576			20
1567495	Stulpleiste SYNEGO® (kaschiert)	36	1620			21
1567505	Pfosten 98 MD SYNEGO® (kaschiert)	24	288			9
1567515	Pfosten 124 MD SYNEGO® (kaschiert)	12	216			10
1865530	Anschlagdichtung grau	500				27

**Artikelverzeichnis**

Art.-Nr.	Bezeichnung	Pack/ Bündel in m	Langgutpalette in m		Karton/ Beutel in Stück	Seite
			Pack	Schrumpf		
1864952	Anschlagdichtung schwarz	500				27

## Zeichenerklärung

	Farbe Schwarz
	Farbe Grau
	Farbe Weiß
	Farbe Cremeweiß
	Farbe Braun
	Farbe Karamell
	Farbe Grün
	Farbe Rot
	Farbe Silber
	Farbe beliebig
	Aluminium natur eloxiert
	Aluminium pressblank
	Kaschierte Ausführung
	Lackierte Ausführung
	Verpackungseinheit (Details siehe Artikelverzeichnis)
	Wanddicke in mm
	Mit verschweißbarer Dichtung
	Mit nicht verschweißbarer Dichtung
	Manuell einzuziehende Dichtung
	Rechte Ausführung
	Linke Ausführung
@	Außerstandard, Lieferzeit auf Anfrage
lx	Trägheitsmoment in X-Richtung in cm <sup>4</sup> bezogen auf E-Modul von Stahl
ly	Trägheitsmoment in Y-Richtung in cm <sup>4</sup> bezogen auf E-Modul von Stahl
	Mit PVC-Kleber verkleben, weiße Profile mit Kleber 251660/251670, kaschierte Profile mit lösemittelfreien Klebstoff (z.B. Cosmofen 515, Fa. Weiss).
	Mit Silikon abdichten
	Mit EPDM-Dichtmasse abdichten
	Mit EPDM-Kleber verkleben
	Linsenkopf-Blechschaube ISO 7049
	Senkkopf-Blechschaube ISO 7050
	Senkkopf-Bohrschaube ISO 15482
	Linsenkopf-Bohrschaube ISO 15481
	Bohr- und Schneidlehre
	Fräsbild
	Alu-Vorsatzschale

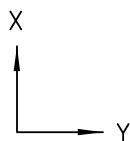

## Variantsystematik

Nach der Artikelnummer (z.B. 550460) folgt eine 3-stellige Variante (z.B. 701), die bei Haupt- und Zusatzspezifischen Vorgaben ist den landesspezifischen Vorgaben anzupassen. Stand 10.2014

**MASTERVORLAGE**











Die Variante besteht aus jeweils 3 Stellen.

1. Stelle steht für Verpackungsart
2. und 3. Stelle stehen für Farbnummern

1. Stelle	Verpackungsart
6	Schlauch-Holzrahmenverschlag (HRV)
7	Schlauch-Langgutpalette (LGP)
8	Schrumpf-Holzrahmenverschlag (HRV)
9	Schrumpf-Langgutpalette (LGP)

2. und 3. Stelle	Farbnummern	
	Profil	Profil/Dichtung
01	Weiß 159	Weiß/Schwarz 159/601
05	-	Weiß/Weiß 159/159
15	-	Weiß/Grau 159/RAL 7001

Beispiele:

- XXXXXX  - Art. in Weiß ohne Dichtung - Var. X01, kleinste Verpackungseinheit 36 m
-  36
- XXXXXX   - Art. in Weiß mit weißer Dichtung - Var. X05, kleinste Verpackungseinheit 24 m
-  24
- XXXXXX   - Art. in Weiß mit grauer Dichtung - Var. X15, kleinste Verpackungseinheit 36 m
-  36
- XXXXXX   - Art. kaschiert mit schwarzer Dichtung - diverse Varianten z.B. gem. Standardfarbtableau, kleinste Verpackungseinheit 24 m
-  24

 Achtung: Nicht alle Profile werden in allen oben gelisteten Varianten angeboten.

## Artikelsystematik in SAP

Mit der Umstellung auf SAP ändern sich die Artikelnummern. Die neuen Artikelnummern sind nun 7-stellig, bestehend aus den vorhandenen 6-stelligen Artikelnummern mit einer „1“ davor. z.B. lautet die vorhandene Artikelnummer 550460 in SAP: 1550460.

## Variantsystematik in SAP

Mit der Umstellung auf SAP ändern sich die Variantennummern. Die neuen Variantennummern sind nun 4-stellig, bestehend aus den vorhandenen 3-stelligen Variantennummern mit einer „1“ davor. z.B. lautet die vorhandene Variantenummer 720 in SAP: 1720.

## Materialnummer

Mit der Umstellung auf SAP werden die nun 7-stelligen Artikelnummern (siehe Artikelsystematik in SAP) und 4-stelligen Variantennummern (siehe Variantsystematik in SAP) zu einer 11-stelligen Materialnummer zusammengefaßt, z.B. 15504601720.

Tableau Standardfarben

**MASTERVORLAGE**  
 ist den landesspezifischen Vorgaben  
 anzupassen. Stand 10.2014

			Varianten											
			1284	1284	1284	1284	1284	1284	1284	1284	1284	1284		
Golden oak 7512	Karamel 15874	Golden oak 7512	1284	1284	1284	1284	1284	1284	1284	1284	1284	1284		
Mooreiche 2 4914	Braun 16827	Mooreiche 2 4914	1756	1756	1756	1756	1756	1756	1756	1756	1756	1756		
Eiche dunkel 1 9638	Braun 16827	Eiche dunkel 1 9638	1752	1752	1752	1752	1752	1752	1752	1752	1752	1752		
Mahagoni 9632	Braun 16827	Mahagoni 9632	1751	1751	1751	1751	1751	1751	1751	1751	1751	1751		
Braun genarbt 9631	Braun 16827	Braun genarbt 9631	1750	1750	1750	1750	1750	1750	1750	1750	1750	1750		
Nussbaum 225L	Braun 16827	Nussbaum 225L	1165	1165	1165	1165	1165	1165	1165	1165	1165	1165		
Anthrazitgrau genarbt 4443	Braun 16827	Anthrazitgrau genarbt 4443	1264	1264	1264	1264	1264	1264	1264	1264	1264	1264		
Anthrazitgrau glatt 930L	Braun 16827	Anthrazitgrau glatt 930L	1203	1203	1203	1203	1203	1203	1203	1203	1203	1203		
Anthrazitgrau genarbt 4443	Weiß 159	Anthrazitgrau genarbt 4443	1364	1364	1364	1364	1364	1364	1364	1364	1364	1364		
Anthrazitgrau glatt 930L	Weiß 159	Anthrazitgrau glatt 930L	1393	1393	1393	1393	1393	1393	1393	1393	1393	1393		
Anthrazitgrau glatt 930L	Weiß 159		1093	1093	1093	1093	1093	1093	1093	1093	1093	1093		
Anthrazitgrau genarbt 4443	Weiß 159		1746	1746	1746	1746	1746	1746	1746	1746	1746	1746		
Mooreiche 2 4914	Weiß 159		1742	1742	1742	1742	1742	1742	1742	1742	1742	1742		
Golden oak 7512	Weiß 159		1741	1741	1741	1741	1741	1741	1741	1741	1741	1741		
Grau 9922	Weiß 159		1737	1737	1737	1737	1737	1737	1737	1737	1737	1737		
Dunkelgrün 9773	Weiß 159		1732	1732	1732	1732	1732	1732	1732	1732	1732	1732		
Eiche dunkel 1 9638	Weiß 159		1722	1722	1722	1722	1722	1722	1722	1722	1722	1722		
Mahagoni 9632	Weiß 159		1721	1721	1721	1721	1721	1721	1721	1721	1721	1721		
Braun genarbt 9631	Weiß 159		1720	1720	1720	1720	1720	1720	1720	1720	1720	1720		
Nussbaum 225L	Weiß 159		1225	1225	1225	1225	1225	1225	1225	1225	1225	1225		
Folienfarbe außen	Farbe Grundkörper (kann abweichen, wenn nicht im Sichtbereich)	Folienfarbe innen	Bezeichnung	Art.-Nr										
			Blendrahmen 72 AD SYNEGO®	1567005		Blendrahmen 82 AD SYNEGO®	1567015		Pfosten 96 AD SYNEGO®	1567405		Pfosten 124 AD SYNEGO®	1567415	
			Blendrahmen 72 MD SYNEGO®	1567105		Blendrahmen 82 MD SYNEGO®	1567115		Pfosten 96 MD SYNEGO®	1567505		Pfosten 124 MD SYNEGO®	1567515	
			Flügel Z 59 SYNEGO®	1567215										

Tableau Standardfarben

**MASTERVORLAGE**  
 ist den landesspezifischen Vorgaben  
 anzupassen. Stand 10.2014











			Varianten								
Golden oak 7512	Karamel 15874	Golden oak 7512	1284	1284	1284	1284	1284	1284	1284	1284	1284
Mooreiche 2 4914	Braun 16827	Mooreiche 2 4914	1756	1756	1756	1756	1756	1756	1756	1756	1756
Eiche dunkel 1 9638	Braun 16827	Eiche dunkel 1 9638	1752	1752	1752	1752	1752	1752	1752	1752	1752
Mahagoni 9632	Braun 16827	Mahagoni 9632	1751	1751	1751	1751	1751	1751	1751	1751	1751
Braun genarbt 9631	Braun 16827	Braun genarbt 9631	1750	1750	1750	1750	1750	1750	1750	1750	1750
Nussbaum 225L	Braun 16827	Nussbaum 225L	1165	1165	1165	1165	1165	1165	1165	1165	1165
Anthrazitgrau genarbt 4443	Braun 16827	Anthrazitgrau genarbt 4443	1264	1264	1264	1264	1264	1264	1264	1264	1264
Anthrazitgrau glatt 930L	Braun 16827	Anthrazitgrau glatt 930L	1203	1203	1203	1203	1203	1203	1203	1203	1203
Anthrazitgrau genarbt 4443	Weiß 159	Anthrazitgrau genarbt 4443	1364	1364	1364	1364	1364	1364	1364	1364	1364
Anthrazitgrau glatt 930L	Weiß 159	Anthrazitgrau glatt 930L	1393	1393	1393	1393	1393	1393	1393	1393	1393
Anthrazitgrau glatt 930L	Weiß 159		1093	1093	1093	1093	1093	1093	1093	1093	1093
Anthrazitgrau genarbt 4443	Weiß 159		1746	1746	1746	1746	1746	1746	1746	1746	1746
Mooreiche 2 4914	Weiß 159		1742	1742	1742	1742	1742	1742	1742	1742	1742
Golden oak 7512	Weiß 159		1741	1741	1741	1741	1741	1741	1741	1741	1741
Grau 9922	Weiß 159		1737	1737	1737	1737	1737	1737	1737	1737	1737
Dunkelgrün 9773	Weiß 159		1732	1732	1732	1732	1732	1732	1732	1732	1732
Eiche dunkel 1 9638	Weiß 159		1722	1722	1722	1722	1722	1722	1722	1722	1722
Mahagoni 9632	Weiß 159		1721	1721	1721	1721	1721	1721	1721	1721	1721
Braun genarbt 9631	Weiß 159		1720	1720	1720	1720	1720	1720	1720	1720	1720
Nussbaum 225L	Weiß 159		1225	1225	1225	1225	1225	1225	1225	1225	1225
Folienfarbe außen	Farbe Grundkörper (kann abweichen, wenn nicht im Sichtbereich)	Folienfarbe innen	Bezeichnung	Art.-Nr							
			Flügel 59 rund SYNEGO®	1567245							
			Flügel Z 86 SYNEGO®	1567235							
			Flügel T 106 SYNEGO®	1567315							
			Hausstürlügel Z SYNEGO®	1567295							
			Hausstürlügel T SYNEGO®	1567305							
			Sprosse 68 SYNEGO®	1567425							
			Stulpprofil SYNEGO®	1567445							
			Blindposten SYNEGO®	1567455							
			Stulpflügel Z 59 SYNEGO®	1567485							



Tableau Standardfarben

**MASTERVORLAGE**  
 ist den landesspezifischen Vorgaben  
 anzupassen. Stand 10.2014

Golden oak 7512	Karamel 15874	Golden oak 7512																		
Mooreiche 2 4914	Braun 16827	Mooreiche 2 4914																		
Eiche dunkel 1 9638	Braun 16827	Eiche dunkel 1 9638																		
Mahagoni 9632	Braun 16827	Mahagoni 9632																		
Braun genarbt 9631	Braun 16827	Braun genarbt 9631																		
Nussbaum 225L	Braun 16827	Nussbaum 225L																		
Anthrazitgrau genarbt 4443	Braun 16827	Anthrazitgrau genarbt 4443																		
Anthrazitgrau glatt 930L	Braun 16827	Anthrazitgrau glatt 930L																		
Anthrazitgrau genarbt 4443	Weiß 159	Anthrazitgrau genarbt 4443	Varianten																	
Anthrazitgrau glatt 930L	Weiß 159	Anthrazitgrau glatt 930L																		
Anthrazitgrau glatt 930L	Weiß 159																			
Anthrazitgrau genarbt 4443	Weiß 159																			
Mooreiche 2 4914	Weiß 159																			
Golden oak 7512	Weiß 159																			
Grau 9922	Weiß 159																			
Dunkelgrün 9773	Weiß 159																			
Eiche dunkel 1 9638	Weiß 159																			
Mahagoni 9632	Weiß 159																			
Braun genarbt 9631	Weiß 159																			
Nussbaum 225L	Weiß 159																			
Folienfarbe außen	Farbe Grundkörper (kann abweichen, wenn nicht im Sichtbereich)	Folienfarbe innen																		
				Bezeichnung	Stujpleiste SYNEGO®															
				Art.-Nr	1567495															
																				



**MASTERVORLAGE**

ist den landesspezifischen Vorgaben  
anzupassen. Stand 10.2014

---

Die in dieser Drucksache angegebenen Maße sind ungefähre Angaben. Für Toleranzen gelten ausschließlich unsere Lieferungs- und Zahlungsbedingungen. Wir empfehlen daher zu prüfen, ob die in dieser Druckschrift genannten Angaben für Ihre vorgesehene technische Lösung geeignet sind.

Anwendung, Verwendung und Verarbeitung unserer Produkte erfolgen außerhalb unserer Kontrollmöglichkeiten und liegen daher ausschließlich in Ihrem Verantwortungsbereich. Unsere Gewährleistung bezieht sich daher in jedem Fall auf die

gleichbleibende Qualität unserer Produkte entsprechend unserer Spezifikation. Sollte eine Haftung in Frage kommen, so richtet sich diese nach unseren Ihnen bekannten allgemeinen Lieferungs- und Zahlungsbedingungen. Diese sind auch abrufbar unter <http://rehau.de/lzb> oder werden auf Anfrage zugesandt. Für Schäden, die aus der Verwendung von anderen als in unseren Unterlagen aufgeführten Original-System-Zubehörteilen herrühren, ist jede Gewährleistung und Haftung von REHAU ausgeschlossen.